

EDITION OF JULY 1881.

SPR 27

Please preserve this for future reference.

CONROY, BISSETT & MALLESON'S

ILLUSTRATED

RETAIL PRICE LIST,

—AND—

HAND-BOOK FOR SPORTSMEN,



[TRADE MARK.]

CONTAINING HINTS AND DIRECTIONS FOR

Fishing, Camping and Archery,

No 65 FULLTON STREET, NEW YORK,

FACTORY 124, 128, 140 & 142 FIRST STREET, BROOKLYN, E. D.

ESTABLISHED 1830.

TO SPORTSMEN.

The want of a complete Illustrated Catalogue and Guide, has long been felt among Sportsmen, particularly those residing out of town. Without something of this kind, it is impossible to order goods in a satisfactory manner. We have endeavored to give such illustrations and directions that any customer, even without previous knowledge of the subject can order a complete outfit, either for Fishing, Camping or Archery, with entire satisfaction to himself.

PERSONAL ATTENTION GIVEN TO OUT OF TOWN ORDERS.

PRICE FIFTY CENTS.

Purchasers may deduct price of Catalogue from first order.

CONROY, BISSETT & MALLESON,

IMPORTERS AND MANUFACTURERS OF

FISHING TACKLE,

AND FINE ARCHERY GOODS,

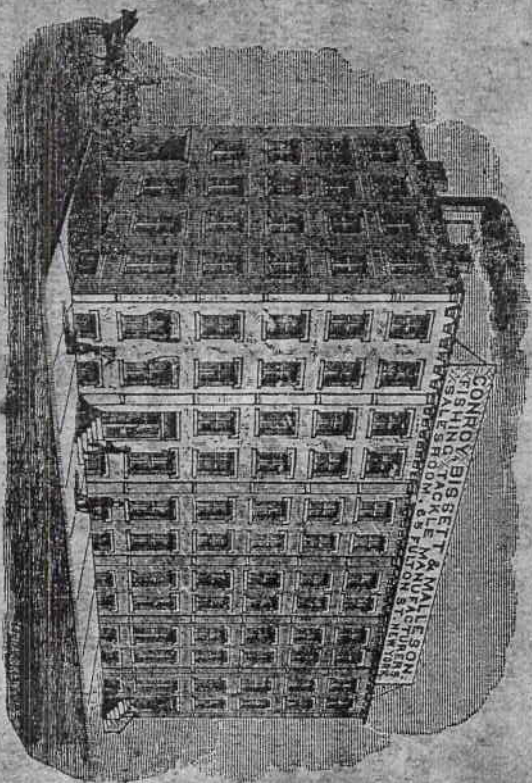

ALSO, MANUFACTURERS OF

MALLESON'S

PATENT SPLIT BAMBOO BOW,

ACKNOWLEDGED SUPERIOR TO ANY DOMESTIC OR ENGLISH BOW.

ARCHERY CATALOGUES SENT FREE ON APPLICATION.

D. MURPHY'S SON, PRINTER, 65 FULLTON STREET, NEW YORK.

TO THE PUBLIC.

Our Hexagonal Split Bamboo Rods

have become so popular that it has started a host of people to imitate them, and as they have neither our experience or the proper bamboo, they turn out inferior work. Anglers are very often prejudiced against Split Bamboo Rods from this very reason. They get hold of some cheap, or even expensive substitute, attracted by some puff, or loud sounding advertisement, and the rod turning out badly, they think that ALL Split Bamboo Rods are inferior. It is much easier for amateurs to make wooden rods, for as we shall show the making of good Split Bamboo requires great skill and experience, in addition to well seasoned and choice material.

In the first place we have a great advantage over all manufacturers in having the largest and choicest selection of well seasoned Bamboo in the country. In making up our rods we use only *absolutely* perfect canes. Small makers cannot do this, for the remainder is useless, and would cause them a heavy loss, while we can put it to many uses in our Factory. This is the reason so much burnt and other unfit Bamboo is found in rods of other makers.

Some makers claim that it is best to use the lower part of the cane for the butt, the next section for the middle joint, and so on. Now this is an error, and they do this for the sake of economy, and not for the reason that it is better. The butt, as every one knows, is much the toughest and hardest, and this part *only* we use in our rods.

As to the number of strips that should be used in making these rods, we claim that our principle of using six is the best, for the simple reason that the strips in a Hexagonal Rod are even on all sides, that is each strip is in shape of an equilateral triangle, thereby making the strongest possible combination, getting the greatest amount of enamel and least quantity of cement. A tip made of 8 pieces contains almost as much cement as cane.

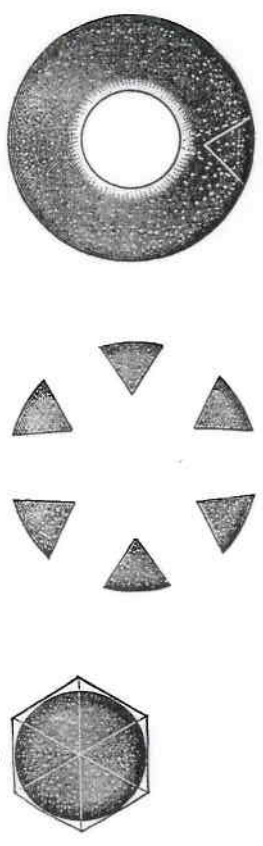

Cut No. 1 shows a transverse section of the cane, and the dotted lines where a piece is split out. It is then planed down to the light line, leaving only the hard enamel.

No. 2 shows the strips ready for cementing, and No. 3 when cemented together.

Our cement used in these rods is waterproof and after once dried it is impossible to separate the strips. The circle on Cut 3 shows how much of the best part of the enamel is lost in making a rod "round" thereby not only weakening it and making the action uneven, but also destroying to a great extent its waterproof quality, for the enamel is in itself a great protection against the influence of dampness.

Our Rods are joined so carefully and closely that the jointings are almost imperceptible, in addition they are varnished with the finest varnish, made expressly for this purpose, rendering them absolutely waterproof. It is much easier to make a round rod, as it requires less skillful workmanship, the file making up for any defect in joining. We therefore claim to give a better Rod for a less price, than any other maker of Split Bamboo Rods, and as a result have a constant and increasing demand, not only here, but also in Europe, for this favorite style of Rod.

These Rods are guaranteed hand made, no machinery used in their manufacture.

CONROY, BISSETT & MALLESON,

RODS.

See Directions for selecting Rods for the different kinds of Fishing.

Six Strip Hexagonal Split Bamboo Salmon Rod, 3 piece, 2 tips, German Silver mountings, metal Reel plate, finest finish and quality guaranteed. Length sixteen to eighteen feet...... each \$50 00

Six Strip Hexagonal Split Bamboo Grilse Fly Rod, 3 piece, 2 tips, German Silver mountings, finest finish and quality guaranteed. Length fourteen to sixteen feet...... each \$35 00
Metal Reel Plate on above Rod \$5 00 extra.

Six Strip Split Bamboo Hexagonal Fly Rod, 2 tips, finest finish, 10 to 12 feet long, 6 1/2 to 10 oz. in weight..... each \$25 00
Same Rod as above, with Extra Middle Joint and Three Tips..... " 35 00
Metal Reel Plates on above Rods extra \$5 00.

These Split Bamboo Fly Rods have a solid well seasoned wooden case, with straight grooves exact shape of the rod, which not only prevents the rods from warping, but restores them to their shape after being used.

Six Strip Hexagonal Split Bamboo "McGinniss" Bait Rod, 3 piece German Silver Mountings, 2 tips, finest finish and quality guaranteed, 12 to 15 oz. in weight, 10 to 12 feet long..... each \$25 00
Same as above, with duplicate joint and 3 tips..... " 35 00

Forest and Stream 6 Strip Hexagonal Split Bamboo Bait Rod, 3 piece German Silver mountings, 2 tips, finest finish, quality guaranteed, 9 oz. 8 1/2 to 9 feet long..... each \$25 00

Six Strip Hexagonal Split Bamboo Light Striped Bass Rod, suitable for Coney Island Creek, Kingsbridge, etc. 8 1/2 to 9 feet long..... each \$25 00

Six Strip Split Bamboo Newport Rod, Ash butt, split Bamboo joint and two split Bamboo tips, agate tube top, wound butt, double guides, German Silver mounting, partition bag. Length 8 1/2 to 9 feet..... each \$30 00

Six Strip Split Bamboo Newport Rod, Ash butt, split Bamboo joint, 2 split Bamboo tips, agate tube top, and double agate guides, wound butt, German Silver mounting and metal reel plate, partition bag. Length 8 1/2 to 9 feet, each \$40 00

Six Strip Hexagonal Split Bamboo "Weak Fish or Southern Bass" Rod, suitable for Southern Trout, small striped Bass, Weak Fish, &c. German Silver mounted, finest finish and quality guaranteed, length 9 feet..... each \$25 00

Six Strip Hexagonal Split Bamboo General Rod, 6 pieces, longest joints 4 1/2 inches, German Silver mountings, wound butt, making 3 distinct Rods, viz: Fly, Bait and Light Trolling. This Rod is suited for Florida, California and Canadian fishing, or for any Black Bass or large Trout fishing..... each \$35 00

REELS.

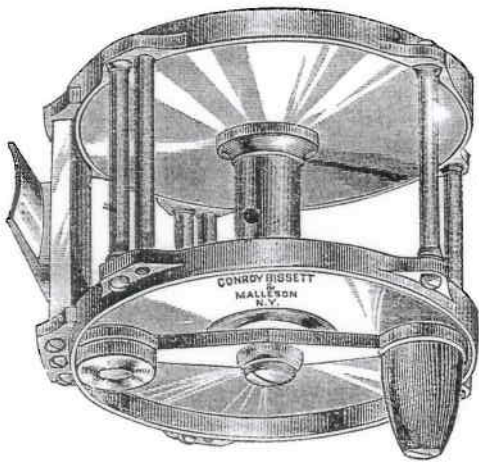

Finest German Silver Salmon Reel, raised pillars, capped click, 120 yds. each	\$30 00
" " " " " " " " " " " "	100 yards... 25 00
" " " " " " " " " " " "	80 " " " " 15 00
" " " " " " " " " " " "	40 " " " " 8 50
" " " " " " " " " " " "	25 " " " " 7 50
Finest Ger. Silver & Rubber Click Salmon Reels, holding 120 yds. each	25 00
" " " " " " " " " " " "	100 " " " " 23 00
Ebonite Click Salmon Reels.....	" " " " 10 00

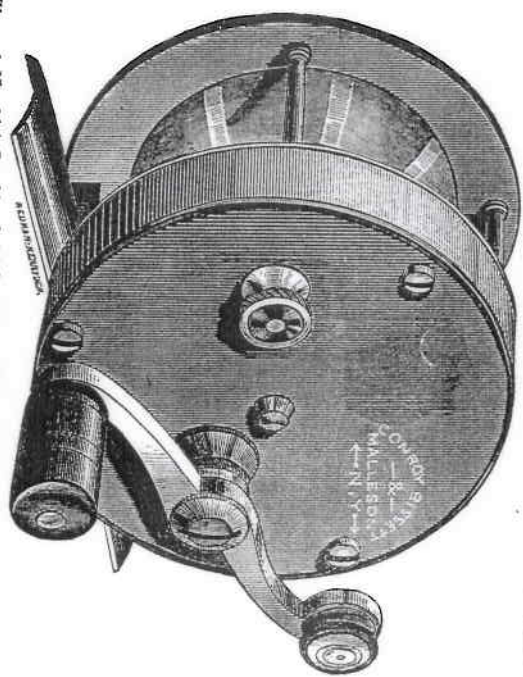

Actual Size of No. 3½ Combined Multiplying Click and Drag Rubber and German Silver Conroy Black Bass Reel.

Pine Rubber and German Silver Combined Multiplying and Adjustable Click Reel, Balance Handle.

No. 2, 100 yards.....	\$13 50.	No. 3½, 60 yards.....	\$10 00
No. 3, 80 yards.....	12 00.	No. 4, 40 yards.....	9 00

This Reel is especially adapted to Western and Southern Black Bass Fishing, made narrow between plates, so as to take up line very fast. Sliding Drag \$1 50 extra.

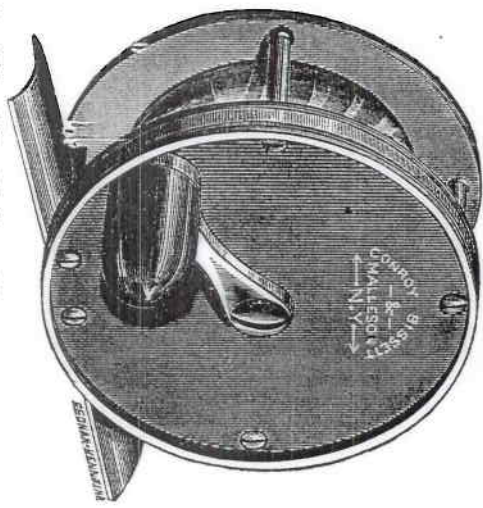

Actual Size of No. 4 Rubber and German Silver Click Reel.

No. 2—Fine Rubber and German Silver Click, German Silver Band, 80 yards... each	\$12 00
" 3— " " " " " " " " " " " "	9 00
" 3½— " " " " " " " " " " " "	7 50
" 4— " " " " " " " " " " " "	7 00
" 4— " " " " " " " " " " " "	90 " " " " 6 50

No. 3½—Fine Rubber and German Silver Click, Rubber Band,	50 yards....	each	7 00
" 4—"	40 "	"	6 50
" 5—"	30 "	"	6 00
" 3½—American German Silver Secret Click, Plates, 80 yards.....		"	6 50
" 4—"	60 "	"	5 50
" 5—"	40 "	"	5 00
" 3½—"	25 "	"	4 50
" 4—"	80 "	"	4 00
" 5—"	60 "	"	3 50
" 6—"	40 "	"	3 00
" 4—Rubber Click, Plates, 60 yards.....	25 "	"	2 50
" 5—"	40 "	"	3 00
" 6—"	25 "	"	2 50

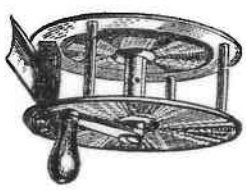

No. 4—Brass Click, Plates, 60 yards..... each 1 75
 " 5—" " " 40 " " " 1 50
 " 6—" " " 25 " " " 1 25
 The Orvis Reel, price in Black Walnut Case..... " 3 50
 The Kentucky Reel..... " 3 50

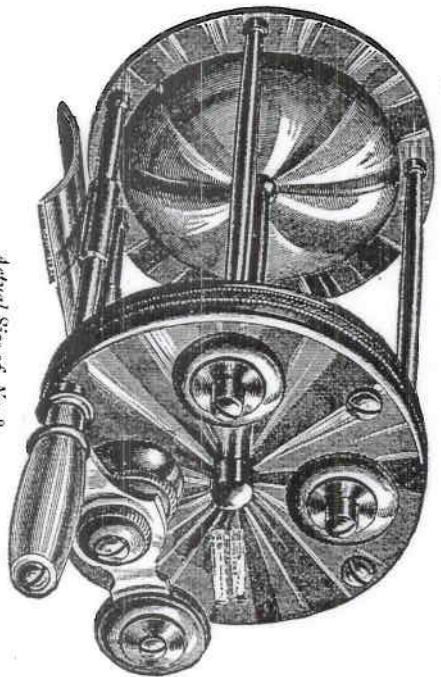

No. 2.....\$14 00. No. 3.....\$15 00. No. 4.....\$16 00
Actual Size of No. 3.
Nickel Combined Multiplying and Click Reel.
 This is a very desirable Reel for Trout or Black Bass, as it can be used as a free running multiplying reel for bait fishing, or with the click for Fly Fishing.
 No. 3½.....\$5 00. No. 4.....\$4 75. No. 5.....\$4 50. No. 6.....\$4 25

Narrow Multiplying Brass Reel, with Adjustable Click, Particularly adapted to Trout and Black Bass Bait, and Fly Fishing.
 No. 3—.....\$5 25 No. 4—.....\$4 75
 " 3½—.....5 00 " 5—.....4 50
 Nickeling.....\$1 00 extra.

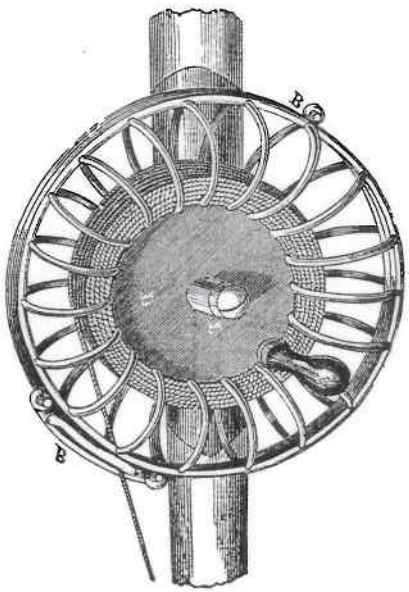

Billingshurst Reels.—Nickeled.
 40 yards.....\$3 00
 60 yards.....\$3 00

Brass Steel Pivots.
 210—300 yards.....each \$10 00
 0—250 " " " 9 50
 1—200 " " " 9 00
 Nickel Plating on above.....1 50c. extra

German Silver Steel Pivots.
 210—300 yards.....each \$17 00
 0—250 " " " 16 00
 1—200 " " " 14 00
 2—150 " " " 13 00
 3—100 " " " 12 00
 Sliding Drags on above.....\$2 00 extra.

Rubber and German Silver Steel Pivots.
 210—300 yards.....each \$22 00
 0—250 " " " 20 00
 1—200 " " " 18 00
 2—150 " " " 16 00
 3—100 " " " 14 00
 Sliding Drags on above.....\$2 00 extra.

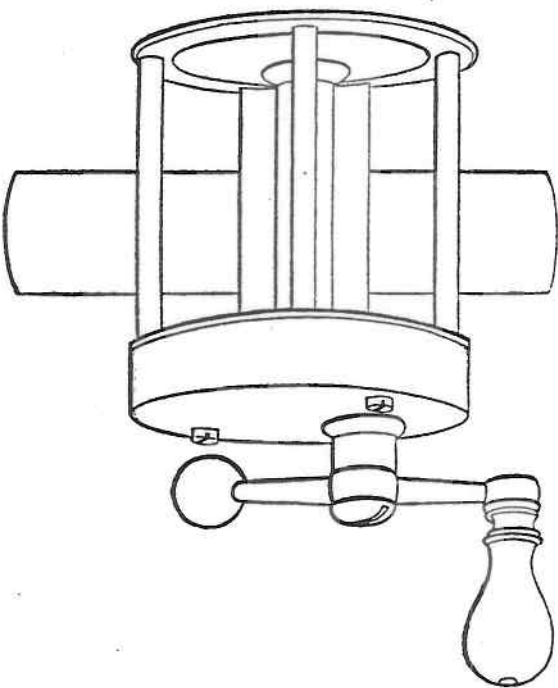

Actual Size Conroy's Extra Quality Balance Handle Multiplying Reel No. 5.

Conroy's Extra Quality German Silver Multiplying Reel, Balance Handle Reel.

No. 1-200 yards.....	each \$8 00
" 2-150 "	" 7 00
" 3-100 "	" 6 50
" 3½-80 "	" 6 50
" 4-60 "	" 5 00
" 5-40 "	" 4 50
" 6-25 "	" 4 00

Drags on above.....each 75c. extra.

Brass Multiplying, Extra Quality Balance Handle Reel.

No. 1-200 yards.....	each \$3 76
" 2-150 "	" 3 50
" 3-100 "	" 3 25
" 3½-80 "	" 3 00
" 4-60 "	" 2 75
" 5-40 "	" 2 50
" 6-25 "	" 2 25

Drags on above.....each 60c. extra.

Nickeling.....1, 2, 3, \$1.00. 3½, 4, 5, 6.....75c. extra.

Balance Handle, Multiplying Reel, with Stops.

No. 3½-80 yards.....	each \$2 50
" 4-60 "	" 2 25
" 5-40 "	" 2 00
" 6-25 "	" 1 75
" 7-15 "	" 1 50

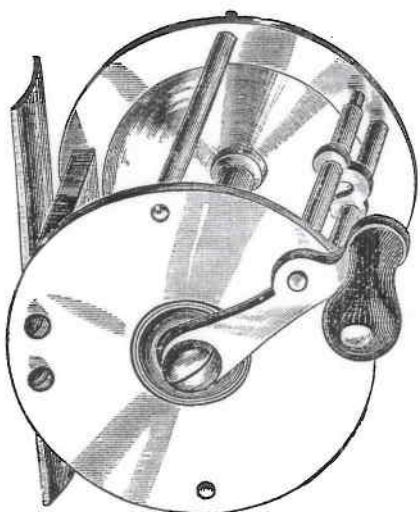

Multiplying Brass Reel, with Stops.

No. 3½-80 yards.....	each \$2 25
" 4-60 "	" 2 00
" 5-40 "	" 1 75
" 6-25 "	" 1 50
" 7-15 "	" 1 25

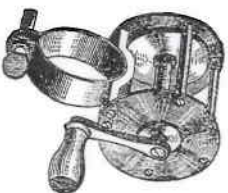

Plain Brass, Rings or Plates, all with Stops.

No. 3½-80 yards.....	each \$1 25
" 4-60 "	" 1 00
" 5-40 "	" 0 80
" 6-25 "	" 0 70
" 7-15 "	" 0 60

ARTIFICIAL BAITS.



Conroy's New Artificial Flexible Minnow, made of Solid Sorr Rubber, which prevents the teeth of the fish from gnawing.

No. 2, 75c. 3, 75c. 4, \$1 00. 5, \$1 00. 6, \$1 00. 7, \$1 25 each.

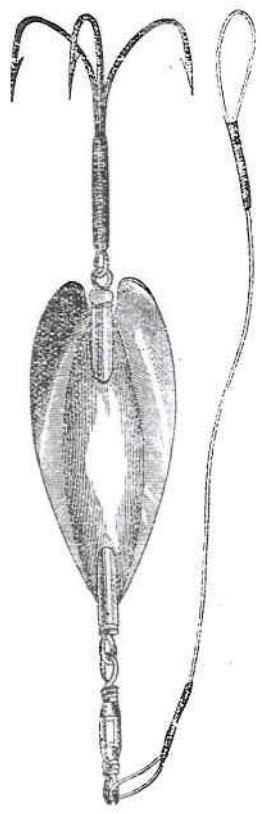

Buel's Spinning Bait.
 2/0,.....\$1 00. 0.....\$1 00. 1, 2, 3.....75c. 4, 5, 6.....60c. each.

Chapman's Improved Minnows.
 No. 0.....\$1 25. 1.....\$1 00. 2.....90c. 3.....80c. 4.....75c. each.

Chapman's Reversible Minnows.
 Nos. 2 and 3.....\$1 00 each

Chapman's Bass Minnows.
 No. 1.....\$1 00. No. 2.....75c. No. 3.....75c. each

The Celebrated Silk Phantom Minnow.
 No. 2.....\$1 00 3.....\$1 00 4.....\$1 00 5.....\$1 00 6.....\$1 25 7.....\$1 25 each

Caledonian Minnows.
 No. 2, 3, 4, 5.....75c. 6 and 7.....\$1 00 8 and 9.....\$1 25

Flat Glass Baits.
 All Sizes.....each 75c

Round Glass Baits.

No. 4, 50c	5, 50c	6, 50c	7, 75c	8, 75c	9, 75c	each
------------	--------	--------	--------	--------	--------	------



Conroy's Best Metallic Fly Baits,

2.....60c.	3.....60c.	4.....60c.	5.....40c.	6.....40c.	each
------------	------------	------------	------------	------------	------

Skinner's Fluted Baits.

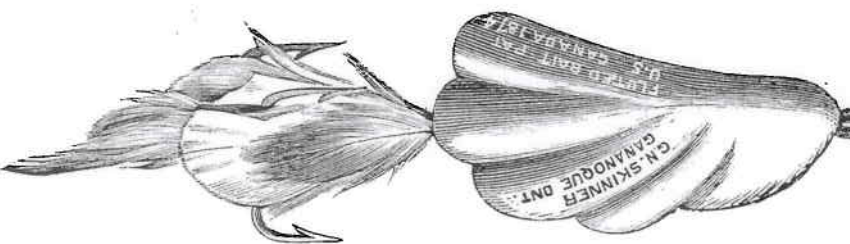

2 65c.	3 65c.	4 65c.	4 1/2 65c.	4 1/2 65c.	5 75c.	6 75c.	7 \$1 00	8 \$1 00	14 65c.	15 75c.	16 75c.	17 \$1 00 each
--------	--------	--------	------------	------------	--------	--------	----------	----------	---------	---------	---------	----------------



Mann's Perfect Revolving Spoon.
 20.....75c. 21.....75c. 22.....75c. each



Mann's Double Fly Spoons.
 10.....\$1 00 1.....90c. 2.....75c. 3.....75c. 3 1/2.....75c. each

Buell's Metallic Fly Baits.

Nos. 210 0 1 2 3 4 5 6
 \$1 00 \$1 00 75c. 75c. 60c. 60c. each.

Feathered Pearl Squids,

For Black Bass.....each \$1 25
 For Pickerel.....each \$1 25 and 1 50

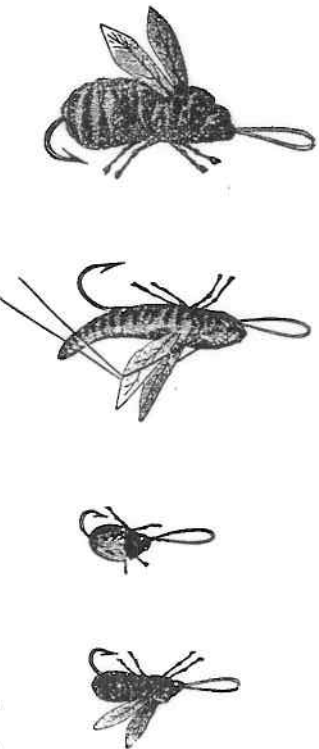

Grasshoppers, winged.....per doz. \$2 25
 Humble Bee....." 2 25
 Crickets and Beetles....." 2 25
 Frogs, Green, Small.....each 0 25
 " " Large....." 0 50

Dobson (Hellgramite),

Small.....each 50c.
 Medium....." 50c.
 Large....." 50c.



Crawfish.....each \$0 50
 James' Florida Spinners.....1 00

Squids, for Weak Fish, Blue Fish and Spanish Mackerel. Pure Block Tin, Burnished.

Nos. 1.....15c. 2.....20c. 3.....25c. 4.....30c. 5.....40c. 6.....50c. each

James' Spinning Squids.

Large.....\$1 00. Small.....50c. each

Pearl Blue Fish Squids.

Large.....\$2 50. Medium.....\$2 25. Small.....\$2 00 each

Round Bone, with Tinned Hooks.

No. 1.....30c. 2.....35c. 3.....40c. 4.....60c. 5.....75c. each

Small Tin Squids, for Weak Fish.

Each.....10c. Per Doz.....\$1 00

Pearl do.

Each.....25c. Per Doz.....\$2 75

Medium Pearl Weak Fish Hooks.

Each.....35c.

Large do. with Piano Wire Snells.

Each.....50c.

Minnow Gangs, for Lake Trout and Black Bass.

On Single Gut.....35c. On Double Gut.....50c. each

On Gimp.....60c. On Twisted Gut.....60c. each

Any Style made to order.

Basket Straps.

Plain Leather.....30c. Web Straps.....50c. Patent Left Shoulder Sling..75c. each

Bait Boxes.

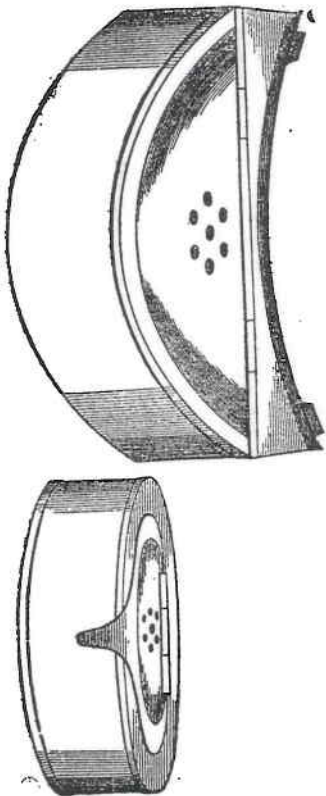

Bait Boxes—Basket. Oval. Large Oval. Padlock. Crescent.
Each 20c. 20c. 25c. 25c. 30c.

Straps for Bait Boxes.....each 25c.

LANDING NETS.

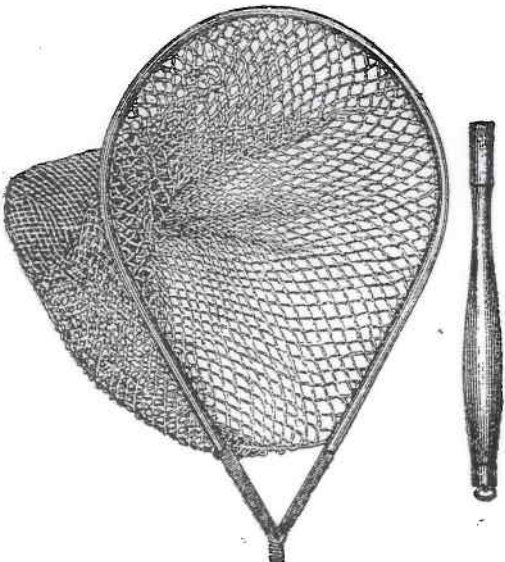

Wooden Frames, with Screw Handles and Landing Net.
Small Size.....\$2 00. Large.....\$3 50 each

Folding Whalebone Landing Net Rings.

For Salmon.....each \$15 00
For Trout and Black Bass.....each \$9 to 10 50
For Salmon with Jointed Bamboo Handle and Landing Net.....each 18 00
For Trout and Black Bass " " " ".....each 12 to 13 50
Plain Brass Rings, Screw Socket.....each 1 50
" " " " Bamboo Handles....." 2 00
" " " " and Jointed....." 3 00
Landing Nets.....extra, each 50c. and 75c.
Brass Folding Ring, Screw Socket.....each \$2 00
Brass Folding Rings with Screw Socket, Bamboo Handle and Net complete.....each \$3 to 3 25
Same as above, with Tip Case Handle.....each 3 75 to 4 00
" " " " Jointed " " " "....." 3 75 to 4 00
Nickelplating extra.....each 50c.

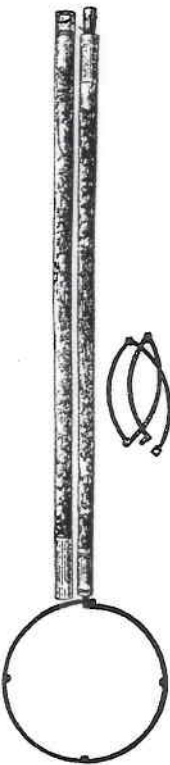

English Four Piece Folding Landing Net Rings, Screw Socket.....each 1 50
Plain Bamboo Handles....." 0 50
Jointed " " " "....." 1 00
Shrimp Nets, with Galvanized Iron Ring and Ash Handles....." 1 25
Crab " " " "....." 0 80
Crab Nets....." 0 20
Landing Nets.....each 50c. to 0 75
Oiled Silk Landing Nets, Trout or Black Bass.....each 1 50
" " " " Salmon....." 2 00
Minnow Nets—16 inch.....50c. 18 inch.....75c. 20 inch.....each 1 00
24 " " " " " ".....1 25 30 inch.....1 50 36 inch....." 2 00
Minnow Netting, all sizes.....per lb. 3 00
Minnow Seines, mounted, 1/4 inch square mesh, 3 feet deep.....per foot, 50c. 4 feet deep.....per foot, 80c.
Any length required.

GAFFS.

Plain Steel Gaffs, small.....each \$0 50
" " " large....." 0 75
With Screw Socket Short Bamboo Handle....." 2 00
" " Bayonet Jointed Bamboo Handle....." 3 00
Plain Steel Salmon Gaff, Nickelplated....." 1 50
Robinson's Screw Socket Steel Salmon Gaff, with Bayonet Jointed Bamboo Handle, Nickelplated....." 4 00

FISH SPEARS.



Fish Spears—No. 1.....75c. No. 2.....\$1 00 No. 3.....\$1 25 each
 Bel Spears—6 Prong.....\$1 25 8 Prong.....1 75 10 Prong.....2 50 each

FLOATS.

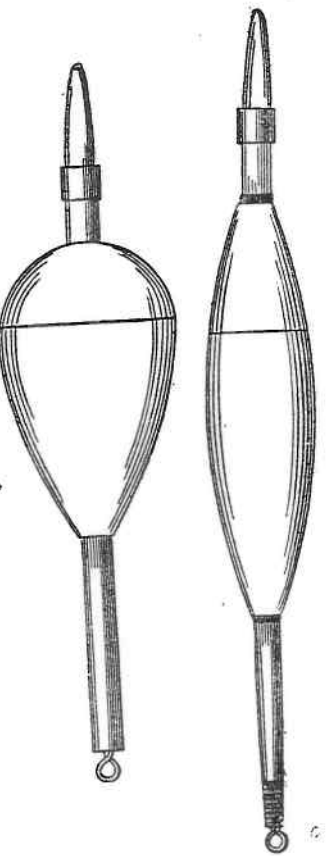

Unbound Egg Shape—Cork.

No. 44.....20c 45.....20c 47.....15c 48.....12c 49.....10c 50.....8c each
 Cork Part, 2 1/4 2 1/4 2 1/4 2 1/4 1 1/2 1 1/2

Bound Egg Shape—Cork.

No. 2.....40c 3.....35c 4.....30c 5.....25c 6.....20c 7.....20c 8.....15c each
 Cork Part, 3 1/4 3 1/2 3 1/2 3 1/2 2 1/2 2 1/2 1 1/2
 No. 29.....15c 30.....15c 31.....12c 32.....12c 33.....12c 34.....12c each
 Cork Part, 1 1/4 1 1/4 1 1/4 1 1/4 1 1/4 1 1/4

Bound Barrel Shape—Cork.

No. 09.....45c 10.....35c 11.....30c 11 1/2.....25c 12.....25c 13.....20c each
 Cork Part 6 6 1/4 4 1/4 4 1/4 4 1/4 4 1/4 3 1/4
 No. 14.....20c 15.....20c 16.....15c 17.....15c 18.....15c 19.....15c each
 Cork Part, 3 1/4 3 1/4 2 1/4 2 1/4 2 1/4 2
 No. 35.....12c 36.....12c 37.....12c 38.....12c 39.....12c each
 Cork Part, 1 1/4 1 1/4 1 1/4 1 1/4 1 1/4

Quill Floats.

No. 48.....10c 54.....10c 58.....15c 62.....20c each

Spiral Floats—Egg Shape.

No. 150.....10c 200.....12c 22. 515 25. 015c each
 Length of body, 1 1/2 2 2 1/4 2 1/2
 No. 300.....20c 301.....12c 401.....15c 601.....20c 601. .30c
 3 4 4 1/4 5 6 inch.

SWIVELS.

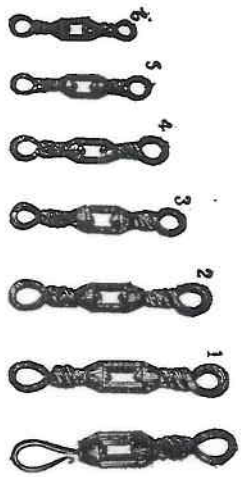

Brass or Steel—

410.....\$2 00 310.....1 50 210.....1 00 0.....75c per doz.
 1 to 10.....60c per dozen.

Watch Spring Steel Swivels.

210.....\$1 50 0.....1 25 1 to 6.....1 00 per dozen

SINKERS.

Swivel—
 No. 310, 210, 0, 1.....\$1 80 per doz.
 No. 2, 3, 4, 5, 6.....1 20
 No. 7, 8, 9, 10, 11.....1 00
 Swivel Sinkers are about one size larger than Ringed of same number.

Hollow Sinkers,

No. 210.....10c 0.....8c 1.....5c 2.....5c 3.....4c
 4.....3c 5.....3c 6.....2c 7.....2c each

Egg Shape Hollow,

No. 1.....10c 2.....8c 3.....7c 4.....6c 5.....4c each
 5.....3c 6.....3c 7.....2c 8.....2c