

Pflueger's Brass Box Swivels

WILL NOT STICK OR BIND

Standard Goods and Sizes



Sizes.....	10-1	1-0	2-0	3-0	4-0	5-0
No. 425. Brass Box Swivels, 1st quality, Per gross	\$1 72	\$2 62	\$3 79	\$5 00	\$7 49	\$10 26

Packed—One gross in a box.

Pflueger's Cross Line Swivels

MADE ONLY IN BEST QUALITY

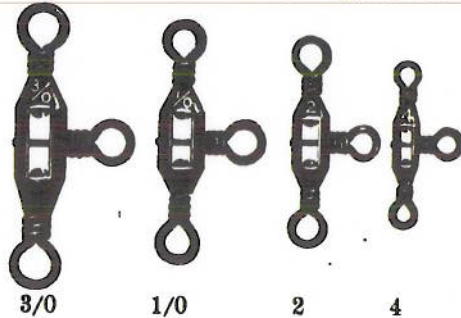

Sizes.....	4-1	1-0	2-0	3-0	4-0	5-0
No. 435. Cross Line Swivels..... Per gross	\$3 15	\$4 20	\$5 25	\$6 95	\$10 20	\$14 40

Packed—One gross in a box.

Pflueger's Brass Barrel Swivels

BEST QUALITY ONLY



This style of Swivel has the box closed, which makes it perfectly sand-proof and will not choke.

Sizes.....	10-8	7	6-4	3	2	1	1-0	2-0
No. 427. Brass Barrel Swivels, 1st quality..... Per gross	\$3 58	\$3 79	\$4 10	\$4 52	\$5 57	\$6 10	\$6 63	\$9 15

Packed—One gross in a box.

Pflueger's "Happy Thought" Trolling Sinkers



No. 514

Mounted with a Split Key Ring and two best quality Brass Box Swivels. Made in all sizes of the Bass Casting Sinkers as shown on page 115.

Sizes.....	10, 9, 8, 7	6, 5	4	3	2	1	1-0	2-0	3-0
Per gross.....	\$10 55	\$11 35	\$12 20	\$13 50	\$15 60	\$17 90	\$23 15	\$27 35	\$31 60

Packed—Three dozen in a box.

Please Order Our Goods Through Your Jobber

Behren's Adjustable and Folding Line Spreaders

Mounted with a Swivel Eye Top and Bottom
Just the thing for Fishing with two Baits on One Line

Patented

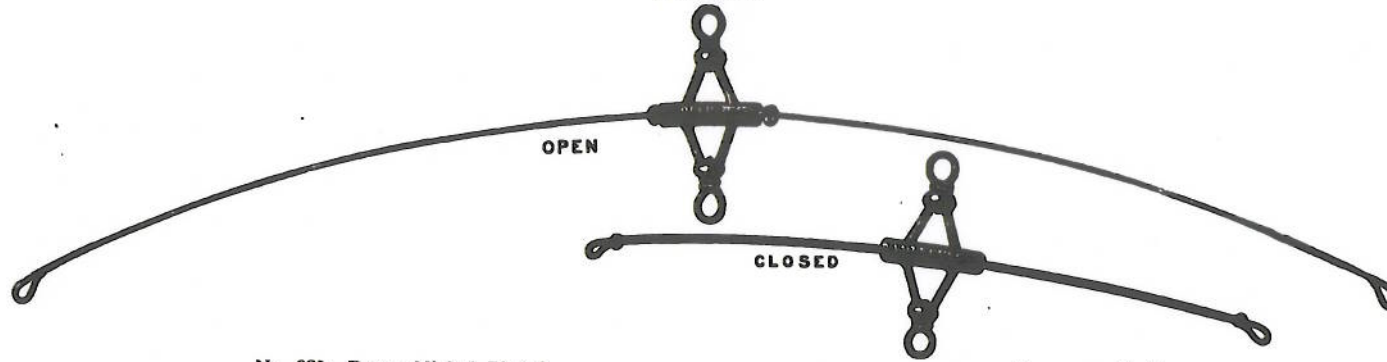

No. 925—Brass, Nickel Plated..... Per gross \$9 46

Mumford's Safety Hook and Bait Box

Patented—No. 807

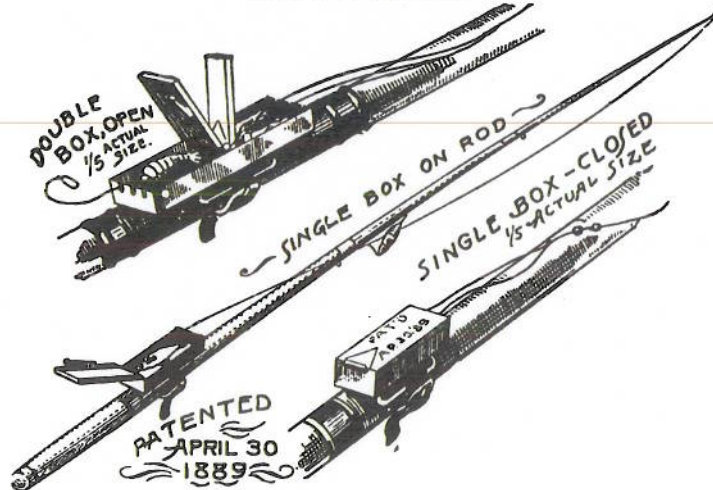

The Bait Box can be securely adjusted to any rod by means of a spring clasp. When moving about in boat or on shore, the hook and bait can be quickly put in box, preserving the bait, avoid tangling the line and constant annoyance of hook catching on everything within reach.

Sizes.... 1 2

No. 807..... Per gross \$4 20 \$6 30
Packed—Half dozen of a size on a Fancy Printed Display Card.

Enterprise Line Spreaders

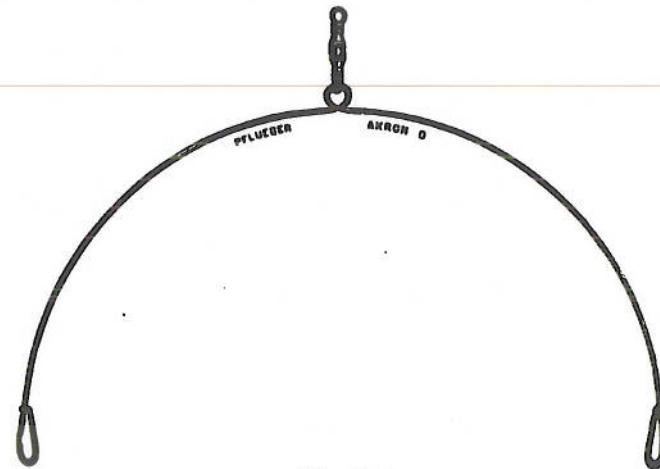

No. 604

Brass, Nickel Plated

No. 604—Brass, Nickel plated with Swivel..... Per gross \$5 06
" 1493— " " without swivel..... " 3 15

Please Order Our Goods Through Your Jobber

PFLUEGER'S FISH CLAMP

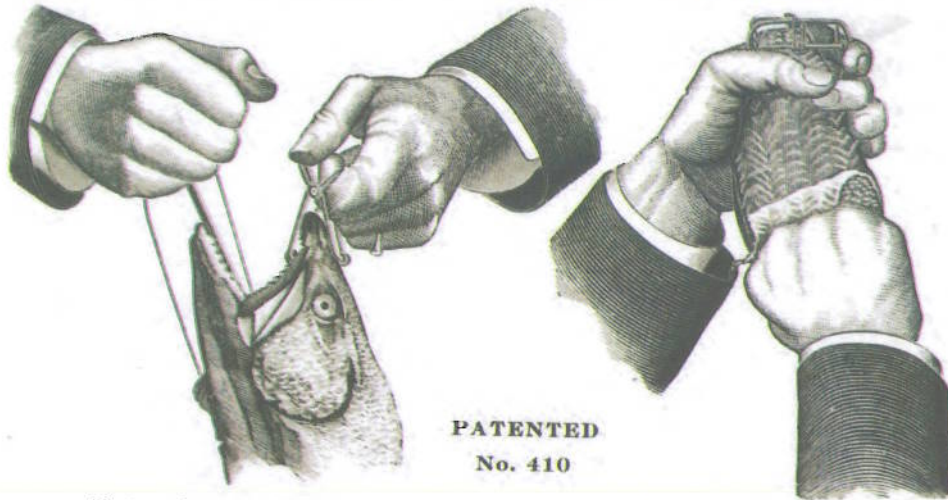

PATENTED
No. 410

Extracting the Hook

By the use of this clamp you can securely hold the fish while extracting the hook (see above cut), also while removing scales and cleaning.

Just the thing to hold eels and other fish while skinning them (see above cut). Also, proves a most handy device for carrying game.

Skinning the Fish

THE VARIOUS USES TO WHICH THIS ARTICLE CAN BE PUT ARE MANY.

Made of best quality Spring Steel Wire—no wear out to it.

No. 410 Price Per gross \$21 04

Pflueger's Slack Line Attachment

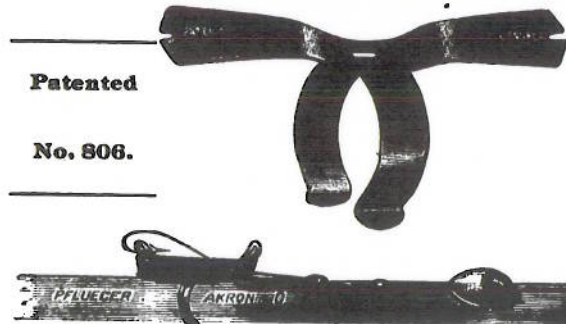

Patented

No. 806.

Adjustable to any size rod. A splendid fixture to securely hold the hook and line when moving from one place to another. It answers the purpose of a Reel.

No. 806 Slack Line Attachment
Per gross..... \$3 14

Packed—Half dozen on a fancy printed display card.

Please Order Our Goods Through Your Jobber

PFLUEGER'S FISH SCALERS



No. 723-Exact Size

PATENTED

A big improvement over "ye olden times." Scales more fish and does it better than the old way.

They will remove scales, fins, heads and tails in less than half the time than the old way with the knife.

No. 728-Cut Shows Half Size

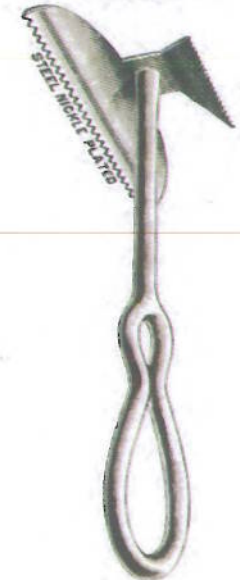

No. 723 Price Per gross \$37 90
" 728 " " 26 30

Packed—No. 723 one in a box; No. 728 two in a box.

Pflueger's Fish and Frog Spears

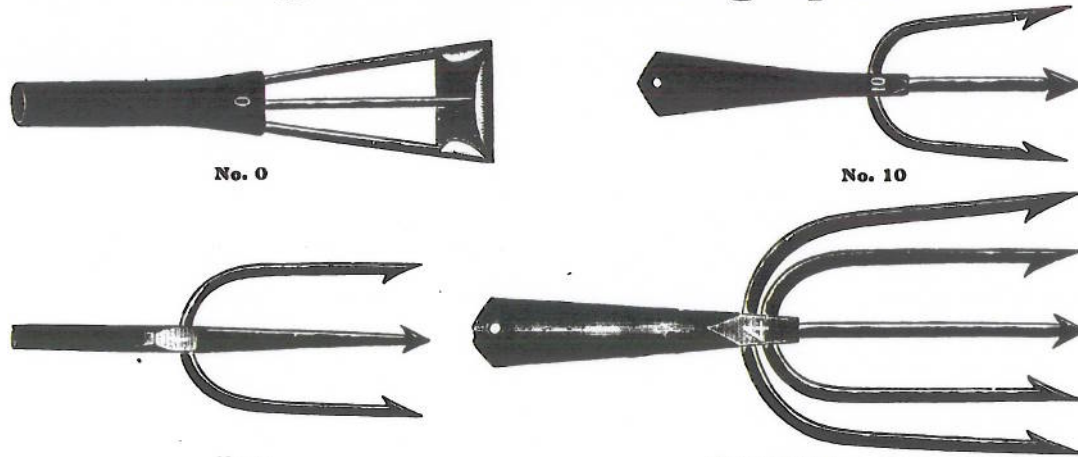

No. 1		Nos. 4 and 5	
No. 0—Socket, 3 prongs, 1½ in. with vest pocket guard.....	Per dozen	"	"
" 1—Tanged, 3 prongs, 2¼ in.....	"	"	"
" 2—Tanged, 5 prongs, 4 in.....	"	"	"
" 20—Socket, 5 prongs, 4 in.....	"	"	"
" 4—Socket, 5 prongs, 4½ in.....	"	"	"
" 5—Socket, 5 prongs, 5 in.....	"	"	"
" 10—Socket, 3 prongs, 2¼ in.....	"	"	"

Prices
Quoted on
Application.

Pflueger's Set Line Snaps

No. 605 Brass



Actual Size

Clamp the corrugated end of snap on the set line, tie a line with a hook on the other end; the snap can be quickly taken off of set line when baiting or setting the line.

No. 605—Wire Snaps..... Per gross \$2 00



Actual Size

Tie the ring to the set line, tie a line with a hook to the snap, which can be readily unsnapped when baiting or setting the line.

No. 140—One ring and one snap comprises a set, price per gross sets.....\$2 10

Pflueger's Set Line Snaps and Rings

No. 140 Brass

Pflueger's Patent Wire Leader

No. 817 Brass, Nickel Plated.



Cut Shows Size of No. 16

Sizes.... 20 18 16 14

No. 817—Brass, Nickel plated..... Per gross \$3 70 \$4 20 \$4 75 \$5 25

Tied to the end of Line, the Spiral Coil enables the fisherman to change the bait and replace another, securely fastening it to the leader with the wire coil. It can be all done in a moment. Sewed on Bronze Printed Cards.

Pflueger's Perfect Connecting Links

No. 606

Brass, Nickel Plated



OPEN

Tied on the end of Fishing Line, the bait can be put on and taken off instantly and securely locked with the sliding sleeve.

Sizes.... 1, 2, 3

No. 606—Brass, Nickel Plated..... Per gross \$ 1 60

Pflueger's Diamond Connecting Links

No. 622

Brass, Nickel Plated

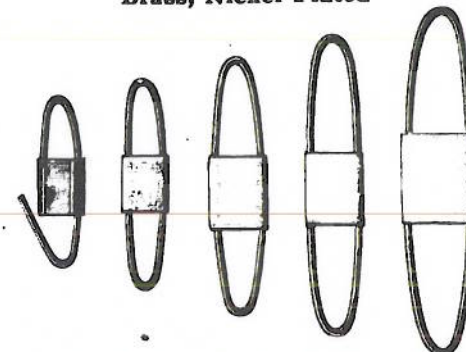

No. 0 No. 1 No. 2 No. 3 No. 4

Used for similar purposes as Connecting Link No. 606. No. 0 illustrates one end of the link opened to receive bait, after which the end of wire is clamped into a groove on the metal band.

No. 622—Brass, Nickel Plated, all sizes.... Per gross \$1 60

Pflueger's Fish Hook Extractors or Disgorgers

No. 3, Brass, Nickel Plated

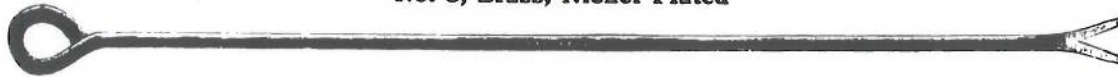

Exact Size

No. 2, Malleable Iron, Bright XC Plated



Exact Size

No. 1, Brass, Nickel Plated



Exact Size

It is the experience of anglers that many a fish, especially large ones, will take the hook or bait well into their stomach, making it necessary to cut the fish open to get the hook out. This can be avoided by using any of the above disgorgers. Directions: Place the line between the flanges of the disgorger, draw it moderately tight, and run the instrument down into the bend of hook, then clasp the line against the side of the shaft and push the whole down until the bait is disengaged, when the hook will readily come out with the disgorger.

No. 1.....	Price per gross	\$30 52
" 2.....	" "	14 73
" 3.....	" "	5 70

Packed { Disgorgers No. 1 are packed 1 Dozen in a box.
 " " 2 " 3 " "
 " " 3 " 6 " "

Pflueger's Shoo Fly Cream

A positive protection against the Black Fly, Mosquito, Midges and other insects.



No. 1285

This preparation is a decided improvement over all others. It contains no tar or animal fat, leaves no stain, is clean, easily applied, washes off readily, leaves the skin soft, smooth and free from irritation, so common with other preparations. It relieves inflammation and pain from sunburn and if used in time will prevent the burning.

No. 1285. Cream in glass pots. Per gross \$31 60

Pflueger's "Hercules" Ferrule and Rod Cement

Just the thing to cement Ferrules on; also to repair broken rods, etc.

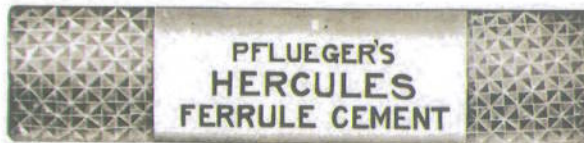

No. 283—Price per gross sticks.....\$12 60

Packed—Each stick in a round, telescope, card box—one dozen sticks in a box.

Pflueger's Handy "Angler's Wax"

Indispensable in the tying of Snell Hooks, Flies, etc.; also repairing small tackle.



No. 821. Price per gross sticks.....\$12 66

Packed—Each stick in a round, telescope, card box—one dozen sticks in a box.

Please Order Our Goods Through Your Jobber

PFLUEGER'S TROLLEY RIGS

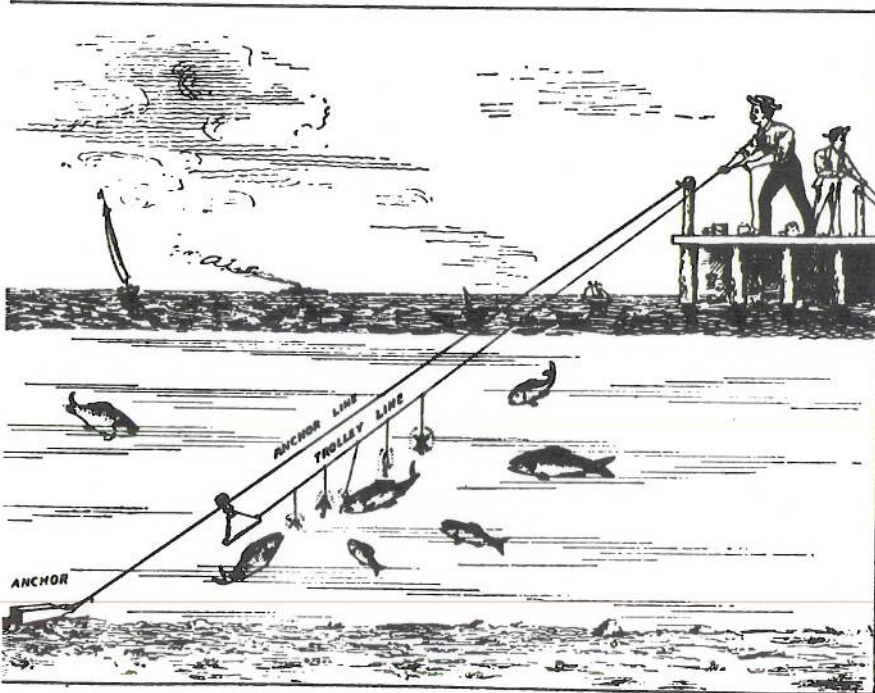

A heavy Lead Anchor is tied to a line of proper strength and thrown into the water as far as you desire. This line known as the Anchor Line (see cut) is made fast to the shore or pier when it is ready for the Split Fork Trolley. On the solid Fork Trolley the anchor line is first passed through the fork and under the pulley before it is made fast. The advantage of the Split Fork Trolley is, it can be readily placed on and taken off without untying the anchor line. To fasten a trolley line (see cut) to the eye of the trolley, tie quantity of hooks at proper intervals and bait them, let the trolley into the water to the desired depth and await developments.

Set No. 340 contains 1 solid brass fork trolley, one 10 oz. lead anchor, Doz. sets \$3 15
 " " 341 " 1 split " " " " 10 " " " " 6 30

Each Set packed in a wooden slide cover box.

PFLUEGER'S FISH STRINGERS

HERCULES STRINGER

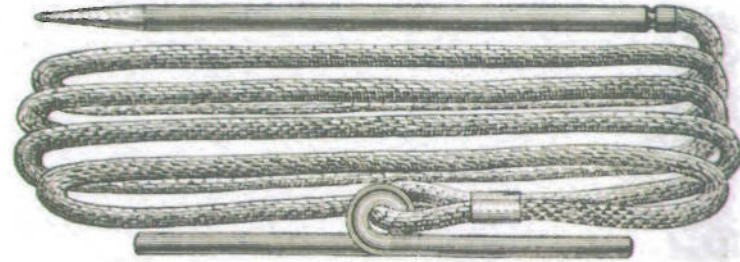

Cut Shows Half Size

Made of heavy braided cord, 6 feet long and securely fastened to the brass needle, leaving no projection to interfere with stringing the fish. The brass bar is made of extra heavy wire, a very safe fastener for the reason that if the bottom fish cuts off, the next one is securely caught.

No. 1890 6-ft long Price per gross \$25 26
 Packed—Each Stringer wrapped in tissue, one dozen in a fancy box.

Braided Line Stringer

No. 805

Cut Shows Half Size

No. 805 XIC Per gross \$5 56
 With heavy braided mottled cotton line.

Packed—Each Stringer sewed on a Bronze Printed Card—One half gross in a box.

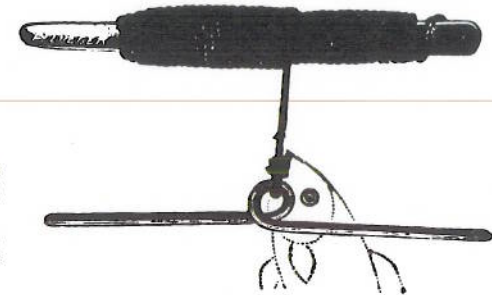

Detachable Chain Stringer

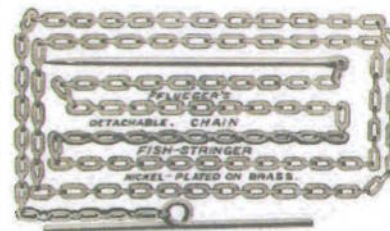

No. 1384 4-ft. Nickel Plated on Brass \$17 90
 " 1385 6-ft. " " " " 31 60

Packed - Each Stringer wrapped in a folder
 One dozen folders in a box.

Please Order Our Goods Through Your Jobber

Pflueger's Steel Gaff Hooks

No. 1288

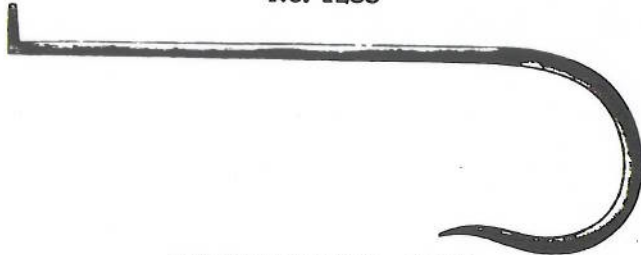

Cut Shows 1/4 Size. Plain

Made of best Steel, properly tempered and nicely Japanned.

No. 1288. Price per gross \$15 16
Packed—Six dozen in a box.



Cut Shows 1/2 Size. Plain with Ferrule

Manufactured from best Steel and Properly Tempered, with a Solid Brass Threaded Ferrule that will fit any Standard Landing Net Rod. Furnished with either a plain or barbed point at same price. Unless specified we will send Plain.

No. 1289. Gaff Hook with Ferrule, Japanned..... Price per dozen \$5 06
" 1290. " " " " Polished Nickel..... " " 7 58
Packed—One dozen in a box.

COMBINATION FISH FORK

Brass, Nickel Plated

No. 721—Cut Shows 2-3 Size

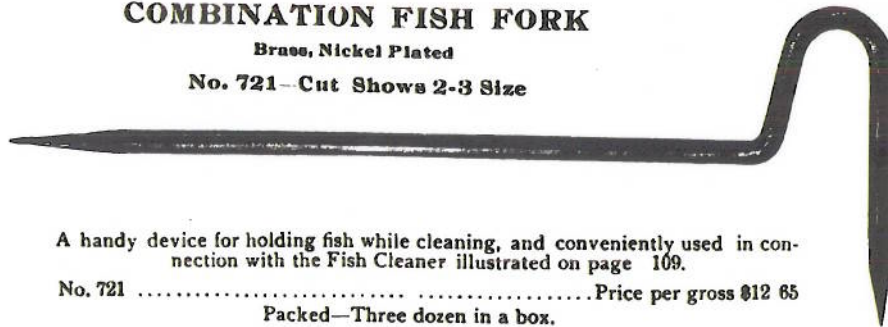

A handy device for holding fish while cleaning, and conveniently used in connection with the Fish Cleaner illustrated on page 109.

No. 721 Price per gross \$12 65
Packed—Three dozen in a box.

Pflueger's Chugging Rig

"A"

PATENTED

A Novel Device to Catch the "Big Ones" on the bottom

DIRECTIONS—Attach trolling spoon or bait on Swivel "B," a weight on Loop "C," and your fishing line on Swivel "A," and continually sound the bottom of river or lake with weight on Loop "C" while moving.

Brass, Nickel Plated—No. 137

No. 137 Price per gross \$15 15

Packed—Sewed on bronze printed cards.

"B"



PFLUEGER'S HANDY LINE WINDER

No. 138

For any kind of lines. No fishing outfit complete without it. Brass, Nickel plated.

No. 138 Brass, Nickel plated..... Price per gross \$3 15
Packed—One dozen in a box.

"C"

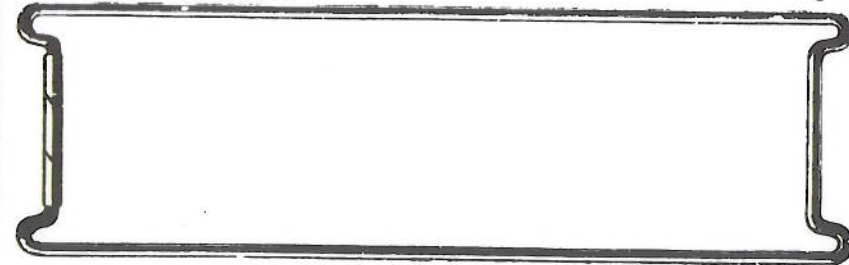

Please Order Our Goods Through Your Jobber

Pflueger's Lead Bank Sinkers, No. 793

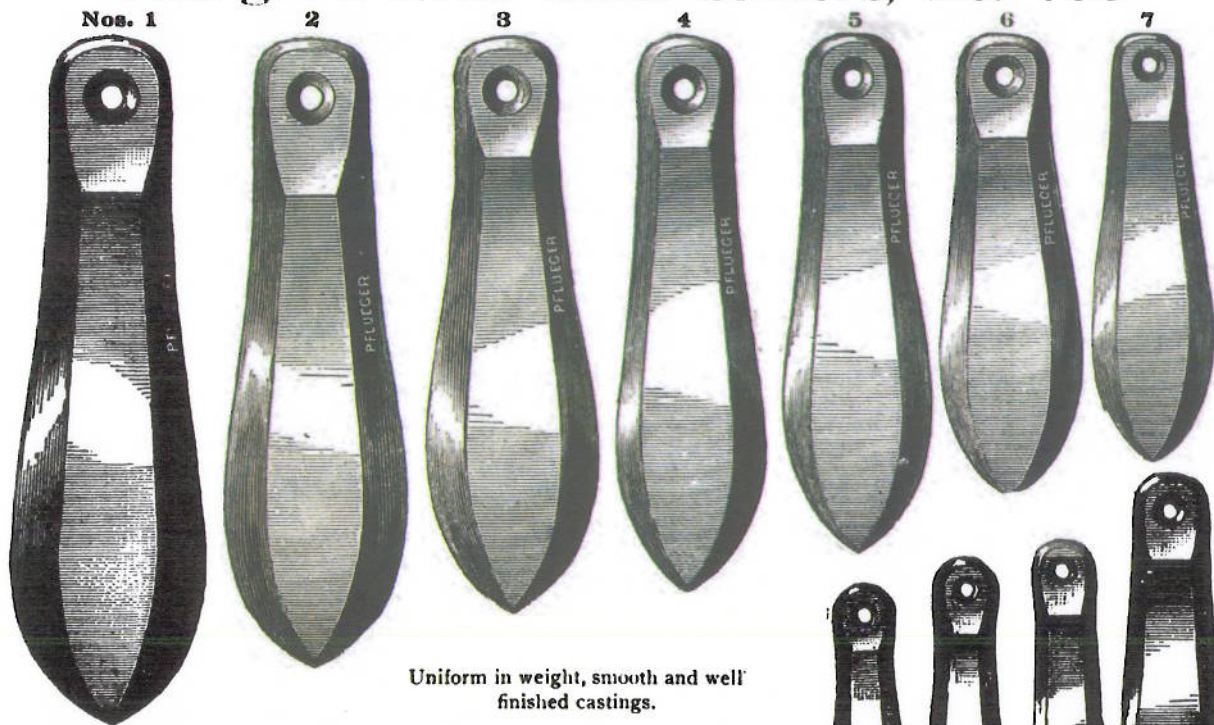

Uniform in weight, smooth and well finished castings.

Sizes.....	1	2	3	4	5	6	7	8	9	10	11
Weight, Ounces, each	11 1/8	8 1/8	6 1/4	5 1/8	4 1/8	3 1/8	2 1/8	1 7/8	1 3/4	1 1/2	1 1/8
Price per hundred pounds	\$12 62					\$13 68			\$14 74		

Lead being the principal item of cost in Bank Sinkers, and the market continually changing, our prices are subject to change without notice.

Pflueger's Oval or Egg-Shaped Lead Sinkers, No. 801

Uniform weight, smooth and well finished castings.

Lead being the principal item of cost in Oval Sinkers, and the market continually changing, our prices are subject to change without notice.

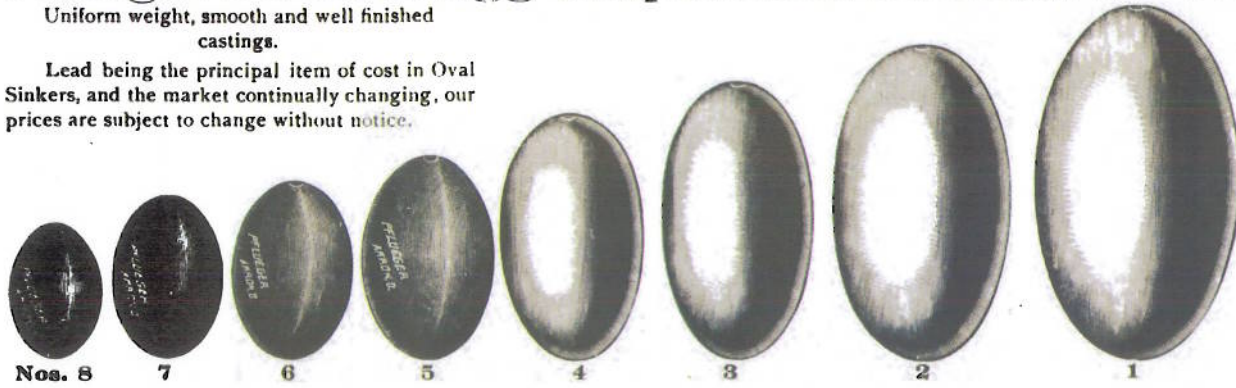

Sizes.....	1	2	3	4	5	6	7	8	9	10
Weight, ounces, each.....	9 1/8	6 1/8	3 7/8	2 1/8	1 1/8	1 3/8	1 1/8	1 1/8	1 1/8	1 1/8
Price per Hundred pounds.....	\$12 62					\$13 68			\$18 94	

Pflueger's Deep Sea Sinkers



No. 791—Weight 3 1/4 Ounces

No. 791. Price per hundred pounds.....\$15 78
Prices subject to change without notice.

Pflueger's Split Shot Sinkers

No. 800



Size of No. 7 Buckshot



Telescope Wood Boxes



Each shot perfectly and properly split. Always ready for additional ballast.

Price per Gross Boxes

Shot sizes.....	BB	7	6	5	4
Shot per box, dozen	2	1	1	1	1
No. 800	\$2 10	\$2 84	\$4 75	\$5 25	\$5 80

Please Order Our Goods Through Your Jobber

Pflueger's Swivel Dipsey or Bass Casting Lead Sinkers

No. 797

Clean and smooth castings. A perfect Swivel working on a brass washer, will not stick or choke.
Standard sizes and full weights. In making comparison with other makers' Sinkers, please note this important point.

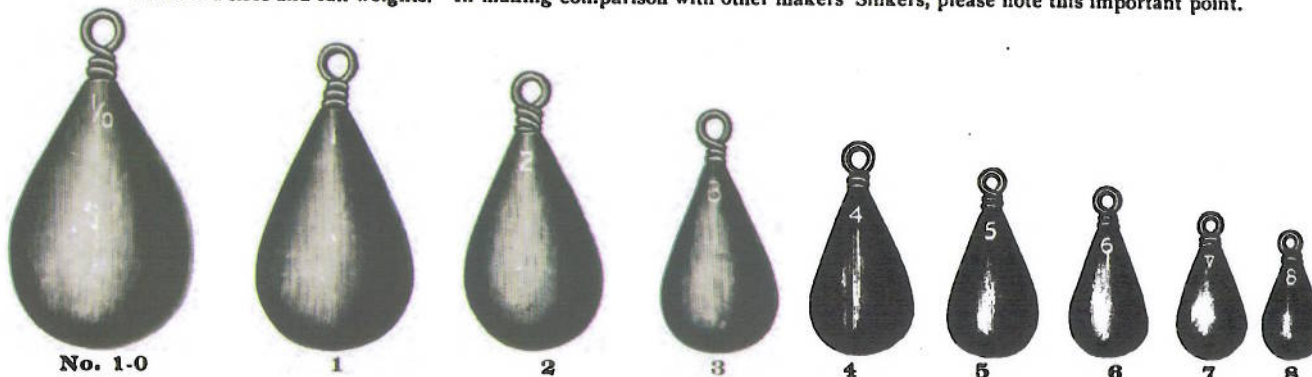

No. 797—Weight ounces	Sizes.....	1-0	1	2	3	4	5	6	7	8	9	10
Price per gross		4 1/4	3 7/8	2 3/4	1 3/4	1 1/4	5/8	1/2	1 1/4	3/4	5/8	1/2
		\$10 10	\$7 83	\$8 66	\$5 80	\$5 26	\$4 92		\$4 54			

Packed—Sizes 1-0 to 6 inclusive—Three dozen in a box. 7-8-9-10—Six dozen in a box.

Pflueger's Lead Worm Sinkers

No. 796



The Worm Sinker can be cut into various weights without altering the principle of attachment. By the method of adjustment to the line there is no possibility of cutting or fraying it, and lays so on the line that it does not require knots or kinks to fasten it.

No. 796—Per gross boxes (1/2 doz. Sinkers in a box)..	Sizes....	1	2	3
Packed—Half dozen Sinkers of a size in a wooden telescope box.		\$14 74	\$16 85	\$18 95

Pflueger's Lead Coil Sinkers

No. 795

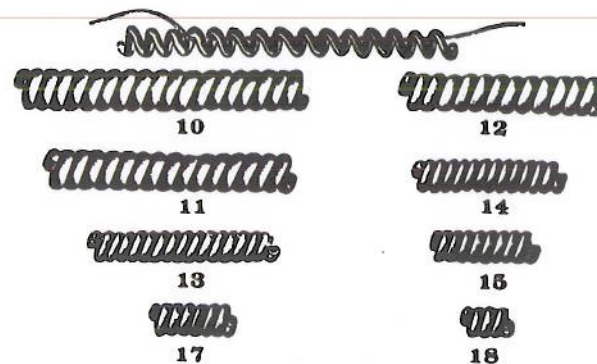

Method of attaching to line—All said opposite regarding the Worm Sinkers applies to the Coil Sinkers.

No. 795—Per gross sinkers.....	Sizes....	18	17	15	14	13	12	11	10
Packed—Three dozen Sinkers of a size in a box.		\$0 63	\$0 75	\$1 05	\$1 25	\$1 60	\$2 10	\$2 40	\$2 65

Please Order Our Goods Through Your Jobber

PFLUEGER'S BRASS RINGED LEAD SINKERS

No. 803

Clean and Smooth Castings

Made with Extra Strong Brass Eyes.
Standard Sizes and full weight. In making comparison with other maker's sinkers please note this important point.

Packed—Quantities in a box as follows: Sinkers Nos. 1, 2, $\frac{1}{4}$ Gross; 3, 4, $\frac{1}{2}$ Gross; 5 to 13 inclusive, 1 gross.

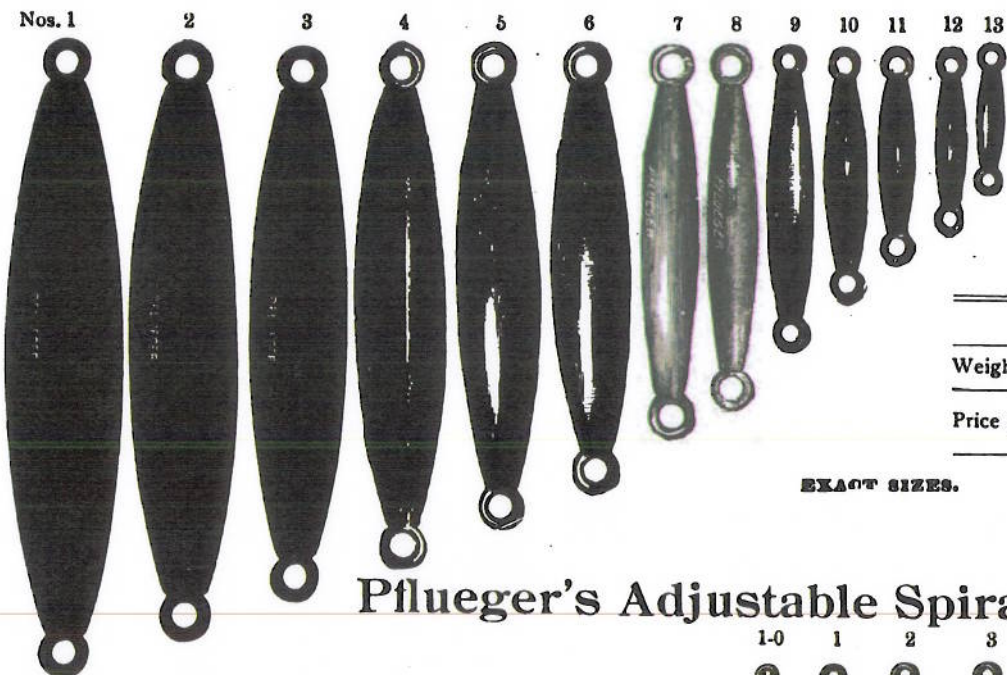

Sizes . . .	1	2	3	4	5	6	7	8	9	10	11	12	13
Weight—Ounces..	$4\frac{1}{8}$	$3\frac{1}{8}$	$2\frac{7}{8}$	$2\frac{1}{8}$	$1\frac{3}{4}$	$1\frac{1}{2}$	$\frac{7}{8}$	$\frac{7}{8}$	$\frac{7}{8}$	$\frac{7}{8}$	$\frac{1}{2}$	$\frac{1}{4}$	$\frac{1}{4}$
Price per gross....	\$4 30	\$3 80	\$2 80	\$2 20	\$1 60	\$1 20	98	76	66	48	46	42	40

EXACT SIZES.

Pflueger's Adjustable Spiral Lead Sinkers. No. 802

The coils on our sinkers are made of brass spring wire and free from sharp edges or burrs, preventing the cutting or fraying of the line. Standard sizes and full weight. In comparing our Sinkers with others please note this important point.

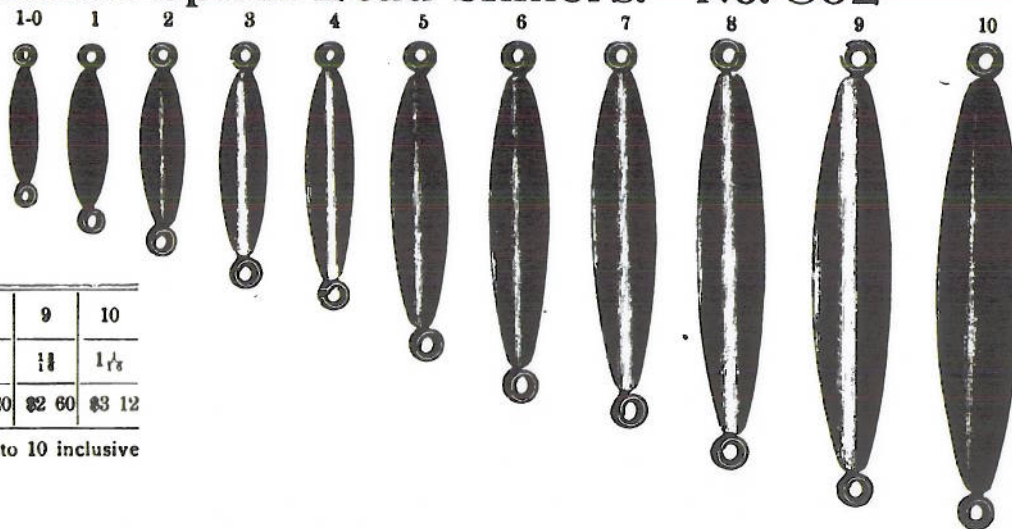

Sizes . . .	1-0	1	2	3	4	5	6	7	8	9	10
Weight—Ounces..	$\frac{1}{8}$	$\frac{1}{4}$	$\frac{3}{8}$	$\frac{1}{2}$	$\frac{3}{4}$	$\frac{1}{2}$	$\frac{7}{8}$	$1\frac{1}{8}$	$1\frac{1}{4}$	$1\frac{1}{2}$	$1\frac{3}{4}$
Price per gross . . .	\$.60	\$.60	\$.79	\$.92	\$1 02	\$1 13	\$1 44	\$1 63	\$2 20	\$2 60	\$3 12

Packed—Quantities in a box as follows: No. 1-0 to 7 inclusive, 1 gross; 8 to 10 inclusive $\frac{1}{2}$ gross.

Please Order Our Goods Through Your Jobber

PLAIN TREBLE HOOKS, RINGED

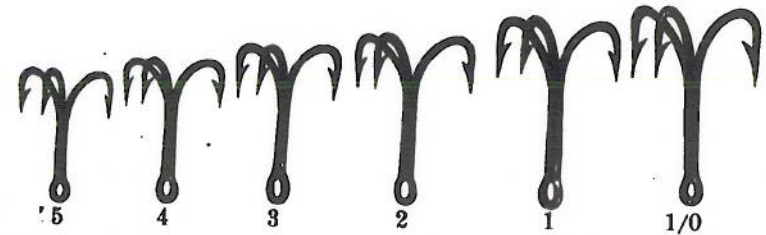
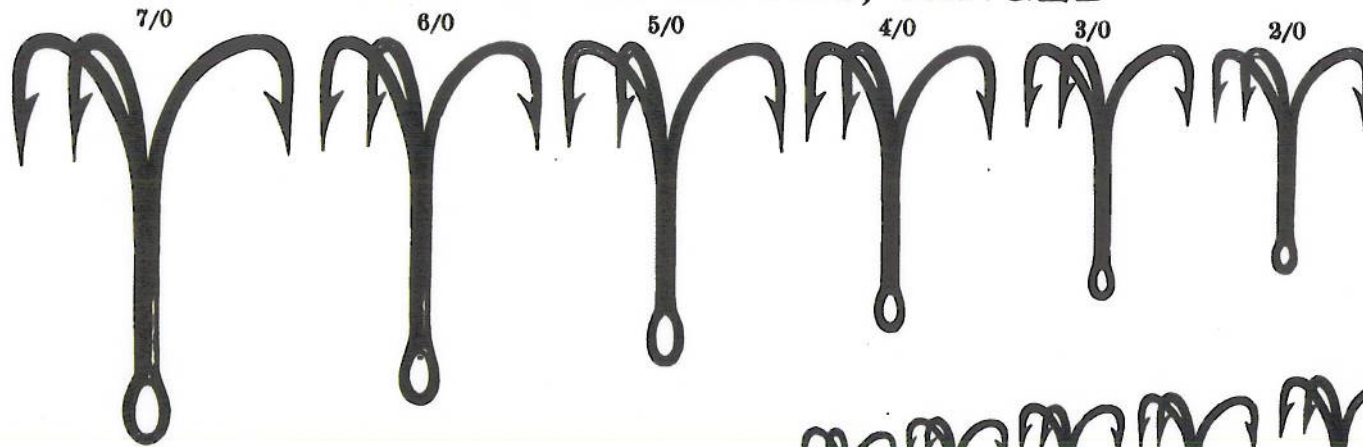

Sizes.....	10-1	1-0	2-0	3-0	4-0	5-0	6-0	7-0	8-0
Grade 1390 Spring steel hollow point treble, ringed or tapered..... Per gross	\$3 16	\$3 68	\$4 21	\$4 73	\$5 47	\$6 62	\$7 79	\$9 47	\$11 58
Grade 1391 Spring steel superior, treble ringed or tapered..... Per gross	1 78	2 00	2 10	2 52	3 04	3 58	4 31	5 05	6 10

FEATHERED TREBLE HOOKS

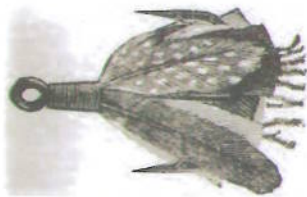

Size 2-0

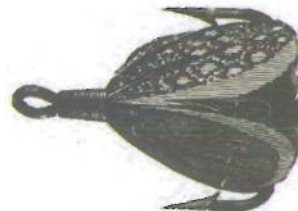

Size 3-0

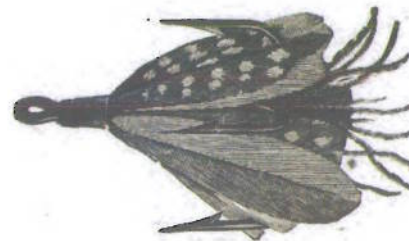

Size 4-0



Size 5-0

We use a liberal assortment of feathers taken from the Ibis, Mallard, Wood-Duck, Guinea, Peacock and other birds of fancy plumage—Bound with best waxed silk thread, painted two coats of water-proof varnish,—Feathers warranted not to pull out or bindings unravel,

Sizes.....	10-1	1-0	2-0	3-0	4-0	5-0	6-0	7-0	8-0
Grade 187 Spring steel hollow point, treble ringed..... Per gross	\$7 85	\$9 68	\$11 65	\$13 21	\$15 99	\$18 73	\$20 10	\$22 10	\$24 20
" 188 " " superior, " "..... " "	3 57	3 78	4 20	4 72	5 04	5 46	5 77	6 09	6 61

Packed—Sizes 12 to 1, four dozen in a box. Sizes 1-0 to 4-0, six dozen in a box. Sizes 5-0 to 8-0, three dozen in a box. If wanted sewed on bronze printed cards add 50c. net per gross extra. For scale of sizes see above.

Please Order Our Goods Through Your Jobber

PFLUEGER'S WEEDLESS HOOKS

No. 350 PERFECTION



Cut Shows Exact Size, 5-0

No. 351 EXPERT



Cut Shows Exact Size, 5-0

	Sizes....	3-0	4-0	5-0	6-0
No. 350—Perfection.....	Per gross	\$15 16	\$15 16	\$15 16	\$15 16
" 351—Expert.....	"	9 48	9 48	9 48	9 48

Packed—Three Hooks sewed on a Perforated Card, one dozen Hooks in a box.

PFLUEGER'S PATENT FLEXIBLE WEED PROTECTORS ON TREBLE HOOKS

Made from Pure Soft Rubber

It is just the thing to attach to your bait for casting among the Lily pads. Must be tried to be appreciated.

Plain



Feathered



Bucktail



PLAIN WEEDLESS

Treble Hooks. Sizes....	7, 6	5, 4	3, 2	1, 1-0	2-0, 3-0	4-0, 5-0
No. 1494—Plain Weedless, first quality.....	Per gross	\$10 55	\$11 60	\$12 10	\$13 70	\$18 40
" 1495— " " second "	"	8 95	10 00	10 55	12 65	15 80
						\$22 10
						18 95

FEATHERED WEEDLESS

Treble Hooks. Sizes....	7, 6	5, 4	3, 2	1, 1-0	2-0, 3-0	4-0, 5-0
No. 1496—Feathered Weedless, first quality....	Per gross	\$12 65	\$13 15	\$13 70	\$15 80	\$20 95
" 1497— " " second " ...	"	11 60	12 10	12 65	14 20	17 90
						\$25 15
						20 50

BUCKTAIL WEEDLESS

Treble Hooks. Sizes....	7, 6	5, 4	3, 2	1, 1-0	2-0, 3-0	4-0, 5-0
No. 1498—Bucktail Weedless, first quality....	Per gross	\$14 20	\$14 80	\$15 42	\$17 78	\$23 58
" 1499— " " second "	"	13 06	13 62	14 24	15 98	20 14
						\$28 30
						23 06

Packed—One dozen in a box, If wanted sewed on Bronze Printed Cards add 50c net per gross extra.

Please Order Our Goods Through Your Jobber

Pflueger's Trolling, Casting and Still Fishing Outfits

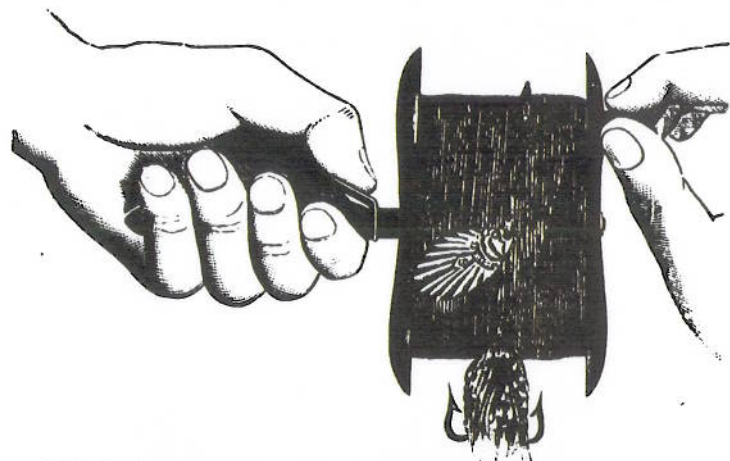

This Reel is made of well seasoned wood, and enameled, assorted colors, Black, Green, Blue and Red, furnished with a lever brake to check Reel, as shown on cut.

Packed—One Outfit in a Fancy Box.

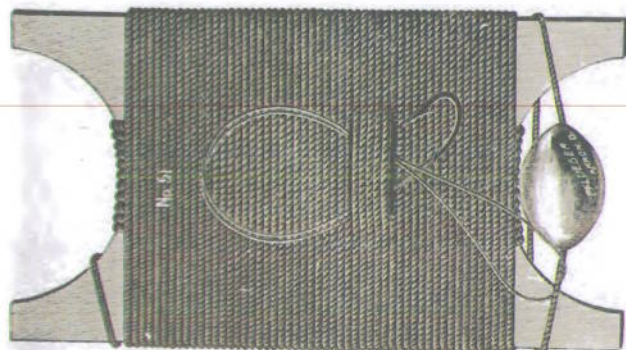

No. 51

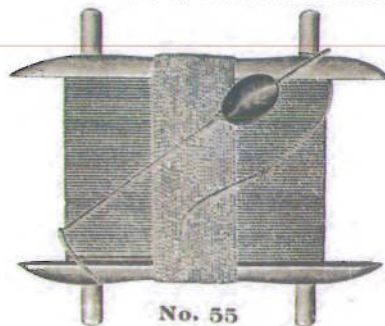

No. 55

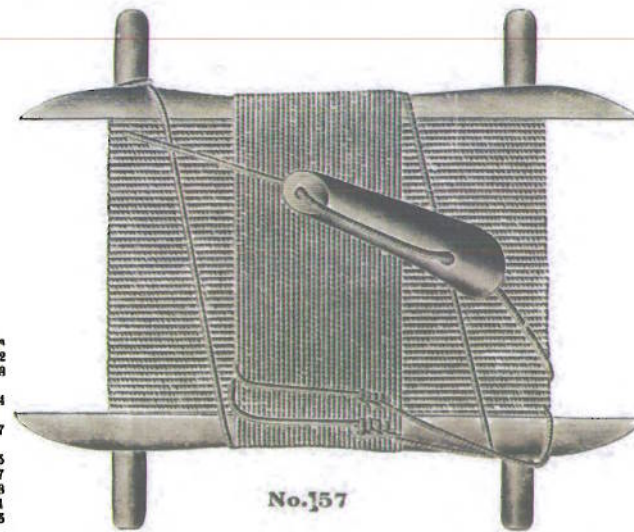

No. 57

Put up on Pflueger's Patented Combination Reel and Line Dryer

Braided Oiled Silk Lines

No. 101. Salmon Line—150 feet finest quality Braided Oiled Silk Line, With No. 9 Luminous Success Spoon, shown on page 66 of catalogue.	\$35.25 dozen
No. 102. Heavy Trolling—150 feet finest quality Braided Oiled Silk Line, with No. 7 Luminous Success Spoon, shown on page 66 of catalogue.	23.10 "
No. 103. Bass Line—150 feet finest quality Braided Oiled Silk Line, with No. 8 Luminous Success Spoon, shown on page 66 of catalogue.	20.00 "
No. 104. Medium Trout—150 feet finest quality Braided Oiled Silk Line, with No. 4 Luminous Trout Fly 2-B grade and a 1 yard Double Gut Leader 10-B grade.	17.90 "
No. 105. Brook Trout—150 feet finest quality Braided Oiled Silk Line, with No. 6 Luminous Trout Fly 2-B grade and a 1 yard Single Gut Leader 10-B grade.	15.80 "

Braided Irish Linen Lines

No. 201. Heavy Bass—150 feet finest quality Braided Linen Line, with No. 7 Luminous Fluted Spoon, shown on page 65 of catalogue.	\$9.45 dozen
No. 202. Medium Bass—150 feet finest quality Braided Linen Line, with No. 5 Luminous Fluted Spoon, shown on page 65 of catalogue.	9.45 "
No. 203. Heavy Trout—150 feet finest quality Braided Linen Line, with No. 4½ Luminous Fluted Spoon, shown on page 65 of catalogue.	9.45 "
No. 204. Medium Trout—150 feet finest quality Braided Linen Line, with No. 4 Trout Fly, 4-A grade and a 1 yard Single Gut Leader 8-B grade.	9.45 "
No. 205. Light Trout—150 feet finest quality Braided Linen Line, with No. 8 Trout Fly, 4-A grade and a 1 yard Single Gut Leader 8-B grade.	9.45 "

Braided Cotton Lines

No. 301. Heavy Trolling—150 feet finest quality Braided Cotton Line, with No. 4 American Spinner, N. L., shown on page 79 of catalogue.	\$7.80 dozen
No. 302. Bass Line—150 feet finest quality Braided Cotton Line, with No. 8 American Spinner, N. L., shown on page 79 of catalogue.	7.80 "
No. 303. Ordinary Fishing—150 feet finest quality Braided Cotton Line, with No. 2 American Spinner, N. L., shown on page 79 of catalogue.	7.80 "
No. 304. Ordinary Fishing, Light—150 feet finest quality Braided Cotton Line, with No. 6 Trout Fly 2-B grade.	5.80 "
No. 305. Pond and Stream Fishing—150 feet finest quality Braided Cotton Line, with No. 9 Carlisle Single Gut Snell and Sawed Shot Sinker No. 7.	5.80 "

PFLUEGER'S FURNISHED DIPSEA LINES

	Per gross
No. 1X. 18 feet Drab Line, No. 10 Egg Sinker, No. 6 File Point Kirby Ringed Hook, Flat Wood Winder. Packed, 1 gross in a box.	\$ 1.52
No. 25. 18 feet Drab Line, No. 9 Egg Sinker, No. 2 Kirby Hook to Single Gut, Flat Wood Winder. Packed, 1 dozen in a box.	3.78
No. 50. 25 feet Imitation Linen Line, No. 8 Egg Sinker. No. 2 Kirby Hook to Double Gut, Flat Wood Winder. Packed, 1 dozen in a box.	4.74
No. 51. 20 feet Imitation Linen Line, No. 7 Egg Sinker. No. 3 Kirby Hook to Single Gut, Flat Wood Winder. Packed, 1 dozen in a box.	5.57
No. 52. 25 feet Imitation Linen Line, No. 6 Egg Sinker. No. 1 Kirby Hook to Single Gut, Flat Wood Winder. Packed, 1 dozen in a box.	7.85
No. 53. 50 feet Imitation Linen Line, No. 5 Egg Sinker. No. 1 Kirby Hook to Single Gut, Flat Wood Winder. Packed 1 dozen in a box.	11.57
No. 55. 50 feet Imitation Linen Line, No. 8 Egg Sinker. No. 2 Kirby Hook Ringed, Four Stave Winder. Packed 1 dozen in a box.	5.78
No. 56. 50 feet Imitation Linen Line, No. 8 Egg Sinker. No. 1 Kirby Hook Ringed, Four Stave Winder. Packed 1 dozen in a box.	10.41
No. 57. 60 feet Imitation Linen Line, 2¼ oz. Deep Sea Sinker. One pair Black Fish Hooks on Line, Four Stave Winder.	22.15

Please Order Our Goods Through Your Jobber

PFLUEGER'S FURNISHED LINES

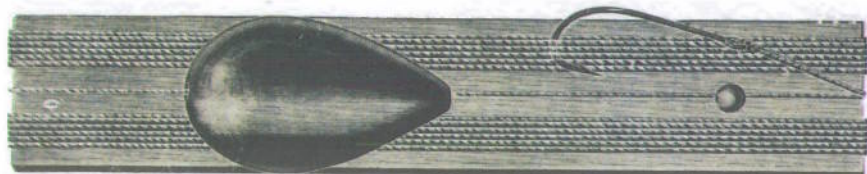
**No. 0**

No. 0—White Cotton Line 12 feet, $1\frac{1}{2}$ inch Egg wood float stained red, without stem. Limerick or Kirby hook ringed, Split shot sinker, Flat wood winder.

Packed—3 dozen in a box. Per gross \$1 20

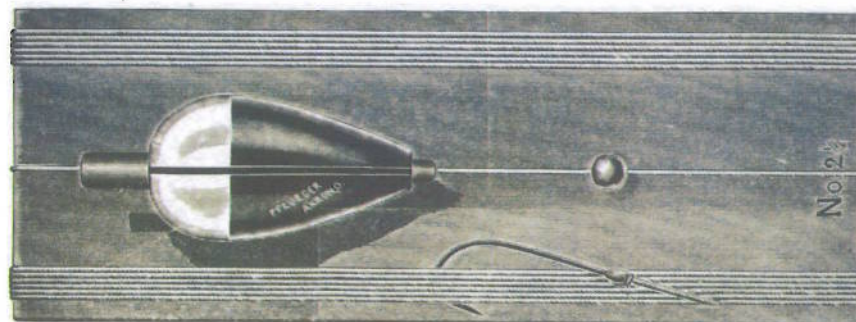
**No. 2 $\frac{1}{2}$**

No. 2 $\frac{1}{2}$ —Drab Cotton Line 12 feet, $1\frac{1}{2}$ inch Egg wood float painted two colors and varnished, slotted with pin. Limerick or Kirby Hook ringed, Split shot sinker, Flat wood winder stained green or blue. Packed 2 dozen in a box. Per gross \$2 86

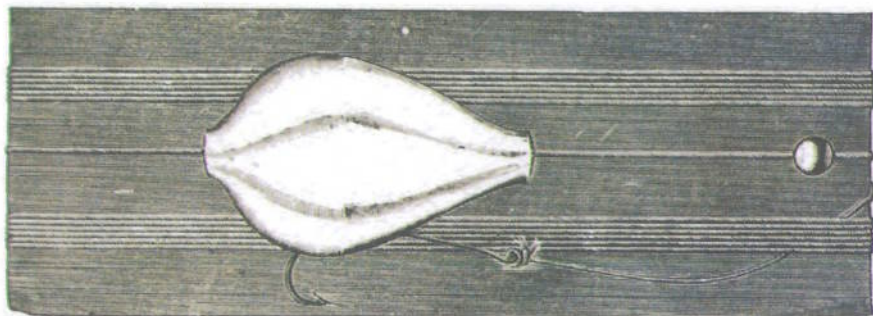
**No. 1**

No. 1—Drab Cotton Line 12 feet, $1\frac{1}{2}$ inch Egg wood float painted one color and varnished, without stem. Limerick or Kirby hook ringed, Split shot sinker, Flat wood winder stained green or blue.

Packed—2 dozen in a box. Per gross \$2 54

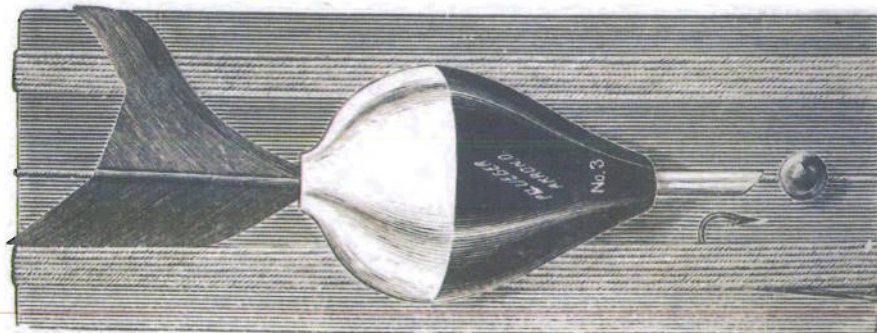
**No. 3**

No. 3—Drab Cotton Line 12 feet. $1\frac{1}{2}$ inch Egg wood float painted two colors and varnished, with a feather fastener. Limerick or Kirby hook ringed, Split shot sinker, Flat wood winder stained green or blue. Packed—2 dozen in a box. Per gross \$3 16

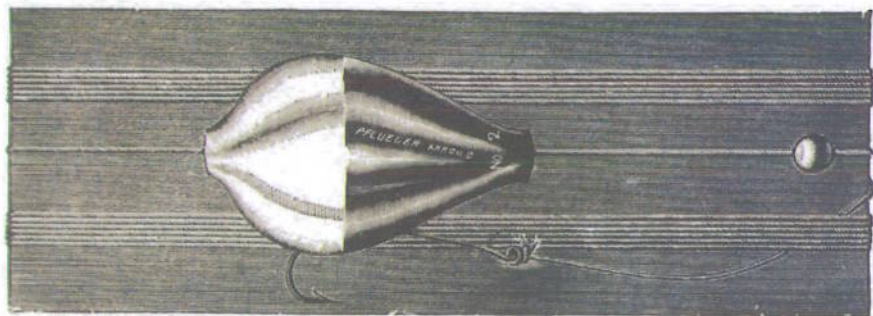
**No. 2**

No. 2—Drab Cotton Line 12 feet, $1\frac{3}{4}$ inch Egg wood float painted two colors and varnished, without stem. Limerick or Kirby hook ringed, Split shot sinker, Flat wood winder stained green or blue.

Packed—2 dozen in a box. Per gross \$2 76

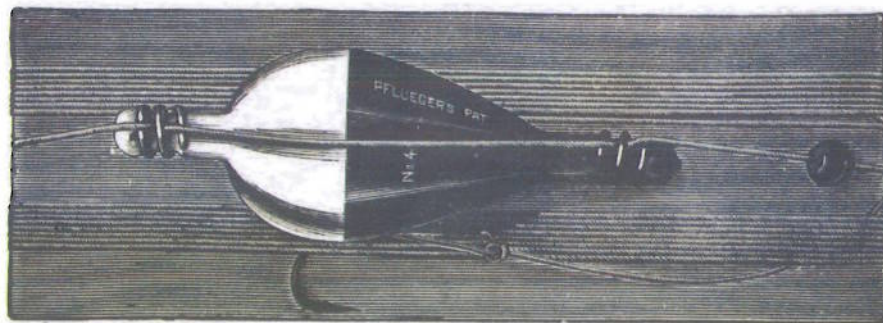
**No. 4**

No. 4—Drab Cotton Line 15 feet, $1\frac{3}{4}$ inch Egg wood float painted two colors and varnished, with Pflueger's patent spiral attachment. Limerick or Kirby hook ringed. Split shot sinker, Flat wood winder stained green or blue.

Packed—2 dozen in a box. Per gross \$4 56

Please Order Our Goods Through Your Jobber

PFLUEGER'S FURNISHED LINES

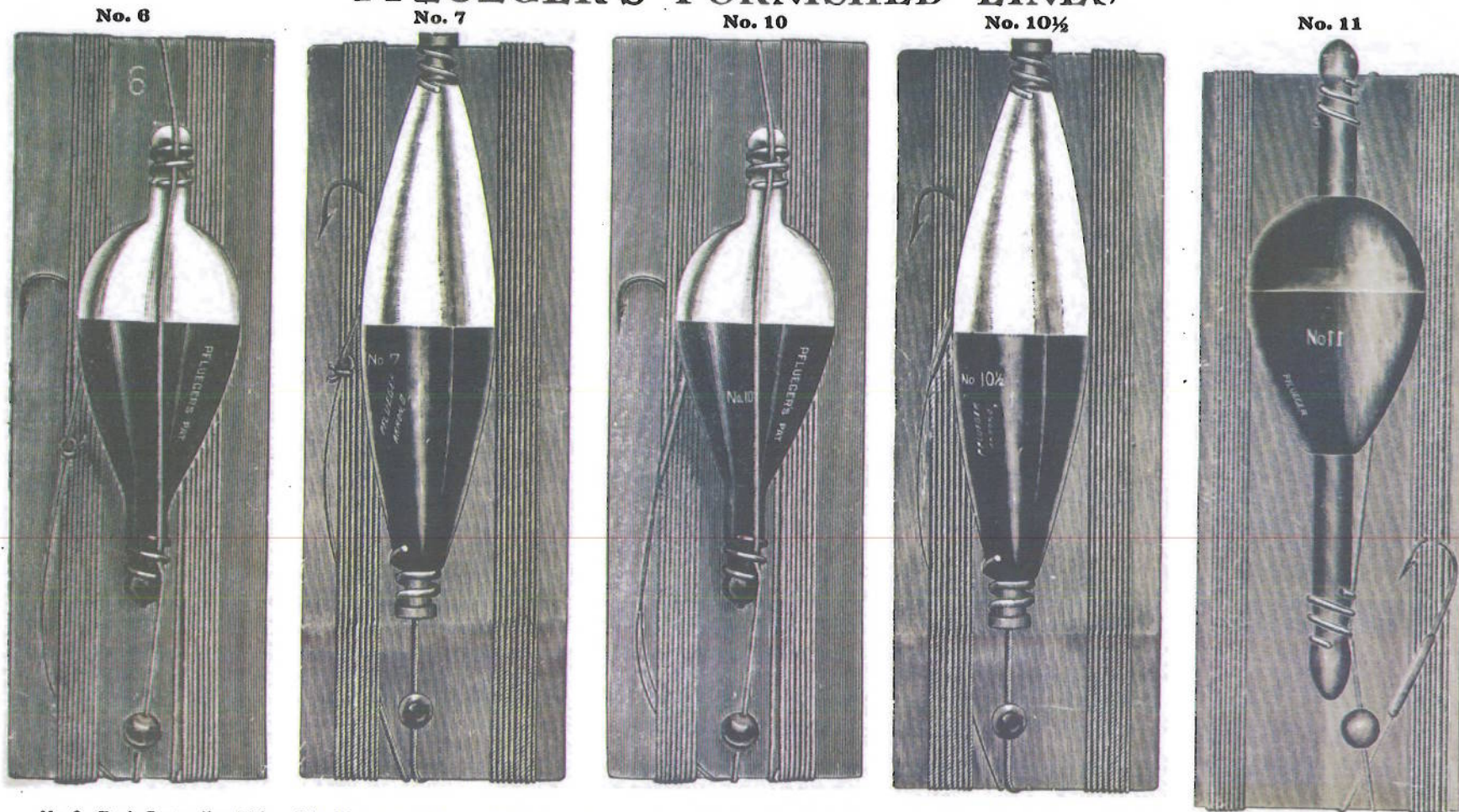

- No. 6 Drab Cotton line 15 feet, 2-in. Egg wood float, painted two colors and varnished, with Pflueger's patent spiral attachment, Limerick or Kirby hook ringed, split shot sinker, flat wood winder, stained..... Price per gross \$6 32
- No. 7 Drab Cotton line 15 feet, 3-in. Barrel wood float, painted two colors and varnished, with Pflueger's patent spiral attachment, Limerick or Kirby hook ringed, split shot sinker, flat wood winder, stained green or blue..... Price per gross 6 32
- No. 10 Sea Island Cotton line 15 feet, 2-in. Egg wood float, painted two colors and varnished, with Pflueger's patent spiral attachment, Carlisle, Limerick or Sproat Double Gut Snell, split shot sinker, flat wood winder, covered with assorted fancy colors enameled paper..... Price per gross 11 58
- No. 10 1/2 Sea Island Cotton line 15 feet, 3-in. Barrel wood float, painted two colors and varnished, with Pflueger's patent spiral attachment, Carlisle, Limerick or Sproat Double Gut Snell, split shot sinker, flat wood winder, covered with assorted fancy colors enameled paper..... Price per gross 11 58
- No. 11 Sea Island Cotton line 15 feet, 1 3/4-in. Egg cork float unbound, enameled two colors, double gut Snelled hook, split shot sinker, flat wood winder, covered with assorted colors enameled paper..... Price per gross 13 16

Packed--All above numbers one dozen in a box.

Please Order Our Goods Through Your Jobber

PFLUEGER'S FURNISHED LINES

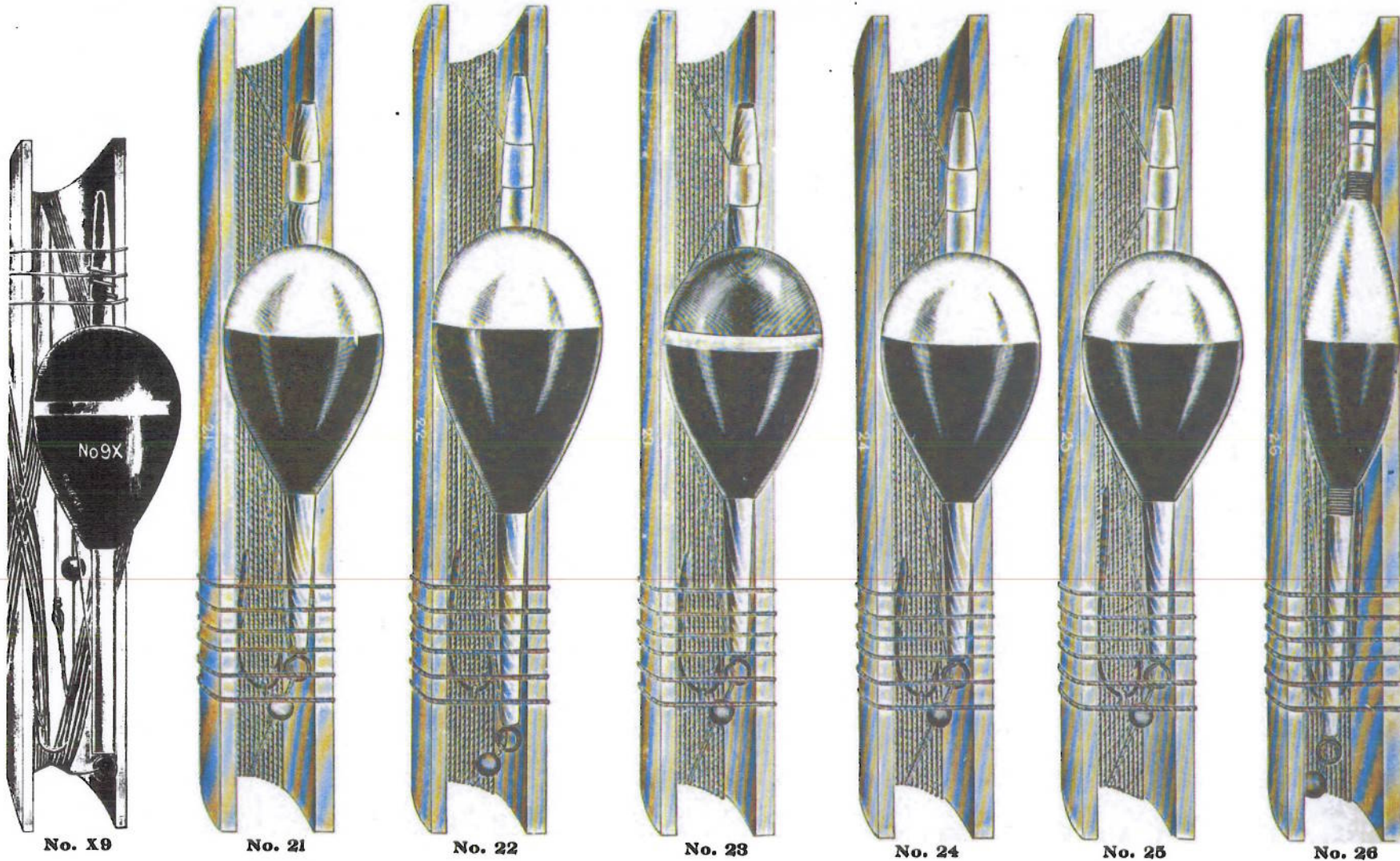

- | | | |
|---------|---|----------------------|
| No. X9. | 12 feet Cotton Line, 1 1/8 inch Egg wood float painted three colors. Limerick or Kirby hook ringed, Split shot sinker, cane winder..... | Per Gross.
\$3 68 |
| " 21. | Drab Cotton Line 12 feet, 1 5/8 inch Stick top Egg wood float painted two colors and varnished. Limerick or Kirby hook ringed. Split shot sinker, Japanese cane winder. Packed—One dozen in a box..... | 4 76 |
| " 22. | Imitation Linen Line 12 feet, 2 inch Quill top Egg wood float painted two colors and varnished. Limerick or Kirby hook ringed. Split shot sinker, Japanese cane winder. Packed—One dozen in a box..... | 6 30 |
| " 23. | Braided Cotton Line 12 feet, 1 5/8 inch Stick top Egg wood float painted three colors and varnished. Limerick or Kirby hook ringed. Split shot sinker, Japanese cane winder. Packed—One dozen in a box..... | 7 56 |

- | | | |
|---------|---|----------------------|
| No. 24. | Braided Linen Line 12 feet, 1 3/4 inch Quill top Egg wood float, painted two colors and varnished, Limerick or Kirby hook ringed, Split shot sinker, Japanese cane winder. Packed—One dozen in a box..... | Per Gross.
\$8 76 |
| " 25. | Twisted Silk Line 12 feet, 1 3/4 inch Quill top Egg wood float, painted two colors and varnished. Carlisle Sproat or Limerick single gut snell, Split Shot Sinkers, Japanese cane winder. Packed—One dozen in a box.. | 14 20 |
| " 26. | Sea Grass Line 12 feet, 2 inch Quill top bound barrel cork float, painted two colors and varnished. Carlisle, Limerick or Sproat single gut snell, Split shot sinker, Japanese cane winder. Packed—One dozen in a box.. | 17 70 |

Please Order Our Goods Through Your Jobber

PFLUEGER'S FURNISHED LINES



No. 27

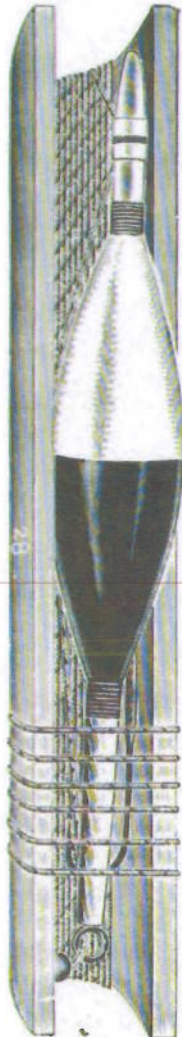

No. 28

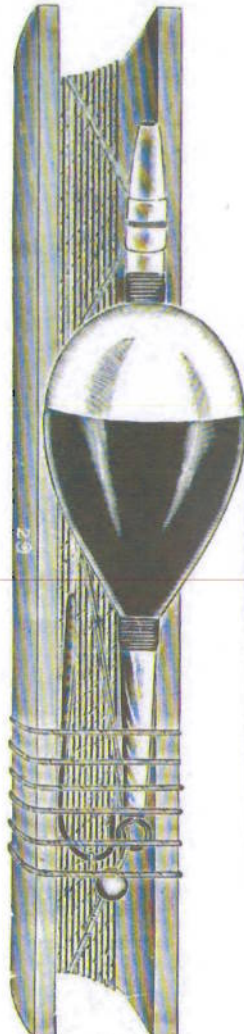

No. 29

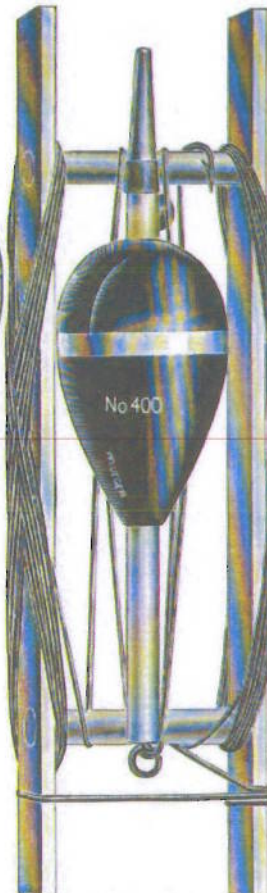

No. 400

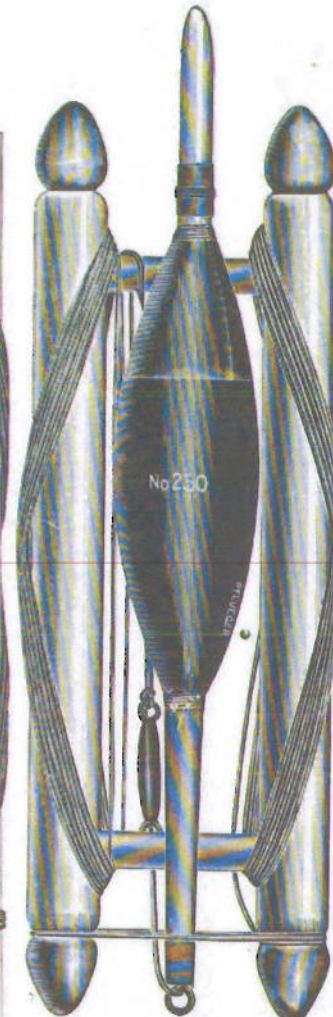

No. 250

- No. 27. Sea Grass Line 12 feet, $1\frac{3}{4}$ inch Quill Top Bound Egg Cork Float, painted two colors and varnished; Carlisle, Sproat or Limerick, Single Gut Snell, Split Shot Sinker, Japanese Cane Winder. Per gross.....\$20 50
- No. 28. Braided Silk Line 12 feet, $2\frac{1}{2}$ inch Quill Top Bound, Barrel Cork Float, painted two colors and varnished; Carlisle, Limerick or Sproat single gut snell, Split Shot Sinker, Japanese Cane Winder. Per gross..... 22 10
- No. 29. Braided Oil Silk Line 12 feet, $1\frac{3}{4}$ inch Quill Top Bound Egg Cork Float, painted two colors and varnished, Carlisle, Sproat or Limerick single gut snell, Split Shot Sinker, Japanese Cane Winder. Per gross..... 24 20
- No. 400. Sea Green Cotton Line 10 feet, $1\frac{1}{2}$ inch Stick Top wood Float, painted three colors, Limerick Ringed Hook, Split Shot Sinker, Frame Winder. Per gross..... 5 78
- No. 250. Braided Silk Line, 11 feet, $2\frac{1}{2}$ inch Quill Top Barrel Float Bound, Enameled two colors and varnished, Ringed Sinker, Carlisle, double gut snelled hook, Fancy Knob Winder. Per gross..... 21 06

Packed—All above numbers, one dozen in a box.

Pflueger's Universal Fishing Tackle Assortment

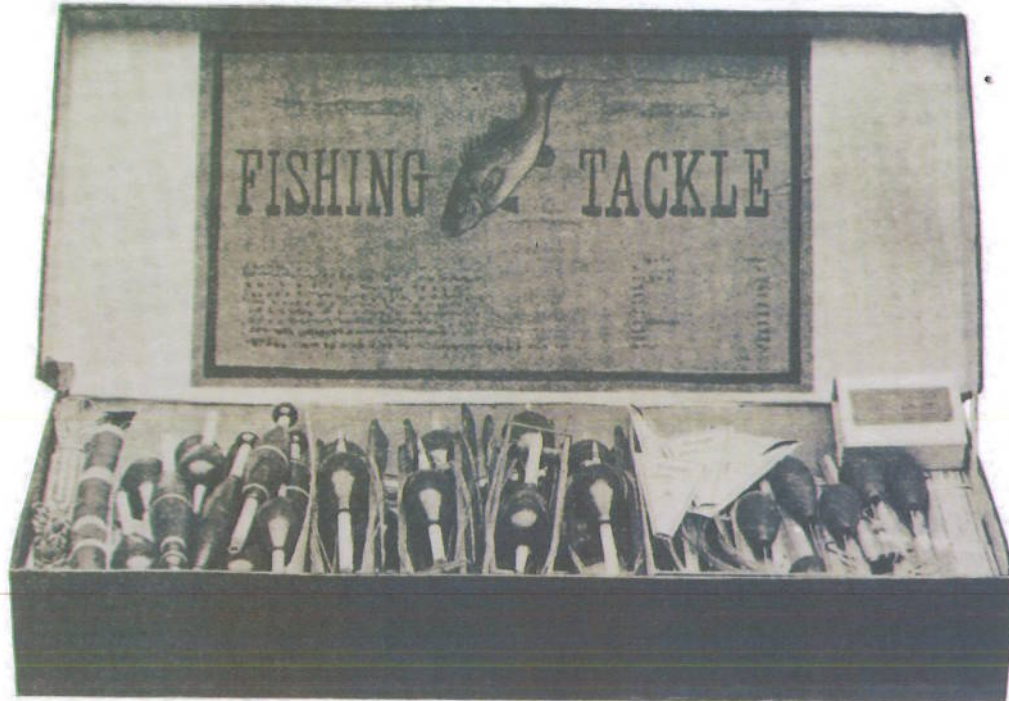

Cut Shows One Third Size

No. 500 Assortment Contains the Following Goods.

	Retail	Total
500 Ringed Fish Hooks Assorted sizes.....	\$.04 per doz	\$1 87
1 Dozen No. 1 Drab fish lines 15 feet, small.....	.01 each	12
1 " " 3 " " " " " medium.....	.02 "	24
1 " " 6 White " " 20 " large.....	.03 "	36
2 " Ringed sinkers, assorted.....	.02 "	48
3 Boxes Split Shot sinkers, 2 dozen in a box.....	.05 per box	15
1½ Dozen No. 0 Furnished lines.....	.01 each	18
1 " " 400 ".....	.04 "	48
1½ " Floats assorted sizes.....	.03 "	54
3 " Hooks to gut, assorted for large and small fish.....	.02 "	72

No. 500 Universal Fishing Tackle Assortment, price per box, \$3.16

4 94

Please Order Our Goods Through Your Jobber

Pflueger's Furnished Set or Trot Lines



Cut Shows 1-3 Size No. 1001

A Complete Furnished Set or Trot Line for River Fishing

No. 1000 Consists of 200-ft extra heavy trot line, with staging loops spaced every two feet. Staging 12-in. long, heavy line, Kirby ringed hooks, assorted 1-0, 2-0, 3-0..... Price per dozen \$18 94

No. 1001 Consists of 200-ft extra heavy trot line, with brass rings tied every two feet for staging. Staging made of heavy line 12-in. long with brass snaps to fasten on rings, tied to Kirby ringed hooks, assorted 1-0, 2-0, 3-0..... Price per dozen \$30 32

The above set lines are wound on a four stave winder. Staging tied, each size hook in a separate wrapper. Packed -One in a box,

Pflueger's Superfine Adjustable Cork Floats

With Pflueger's Patent Spiral Line Fastener, Enameled in Assorted Colors Green and Red

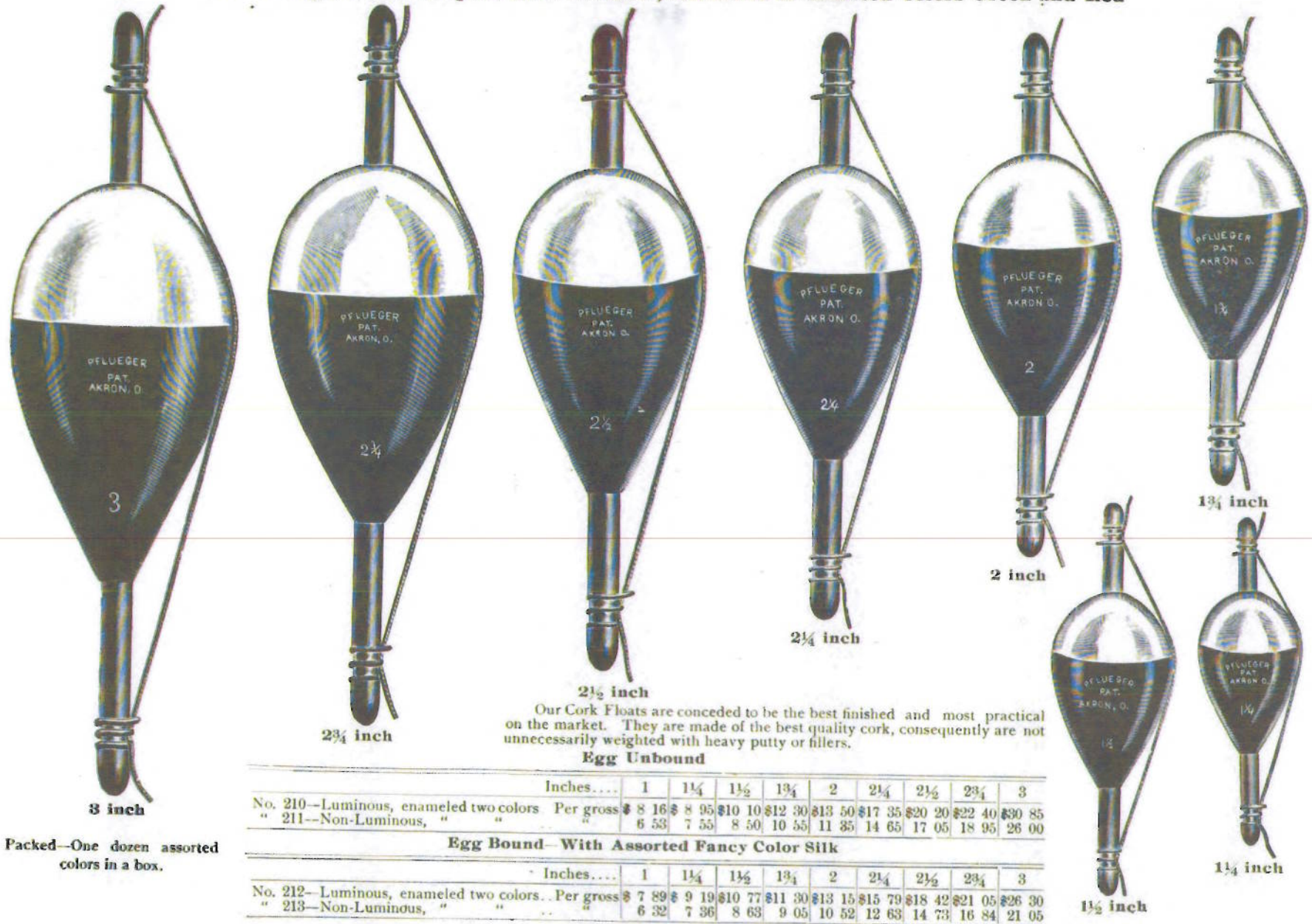

Our Cork Floats are conceded to be the best finished and most practical on the market. They are made of the best quality cork, consequently are not unnecessarily weighted with heavy putty or fillers.

Egg Unbound

Inches....	1	1 1/4	1 1/2	1 3/4	2	2 1/4	2 1/2	2 3/4	3
No. 210--Luminous, enameled two colors	Per gross \$ 8 16	\$ 8 95	\$10 10	\$12 30	\$13 50	\$17 35	\$20 20	\$22 40	\$30 85
" 211--Non-Luminous, " " " " " " " " " "	6 53	7 55	8 50	10 55	11 35	14 65	17 05	18 95	26 00

Egg Bound-- With Assorted Fancy Color Silk

Inches....	1	1 1/4	1 1/2	1 3/4	2	2 1/4	2 1/2	2 3/4	3
No. 212--Luminous, enameled two colors	Per gross \$ 7 89	\$ 9 19	\$10 77	\$11 30	\$13 15	\$15 79	\$18 42	\$21 05	\$26 30
" 213--Non-Luminous, " " " " " " " " " "	6 32	7 36	8 63	9 05	10 52	12 63	14 73	16 84	21 05

Please Order Our Goods Through Your Jobber

Packed--One dozen assorted colors in a box.

PFLUEGER'S SUPERFINE ADJUSTABLE CORK FLOATS

With Pflueger's Patent Spiral Line Fastener--Enameled in Assorted Colors, Green and Red

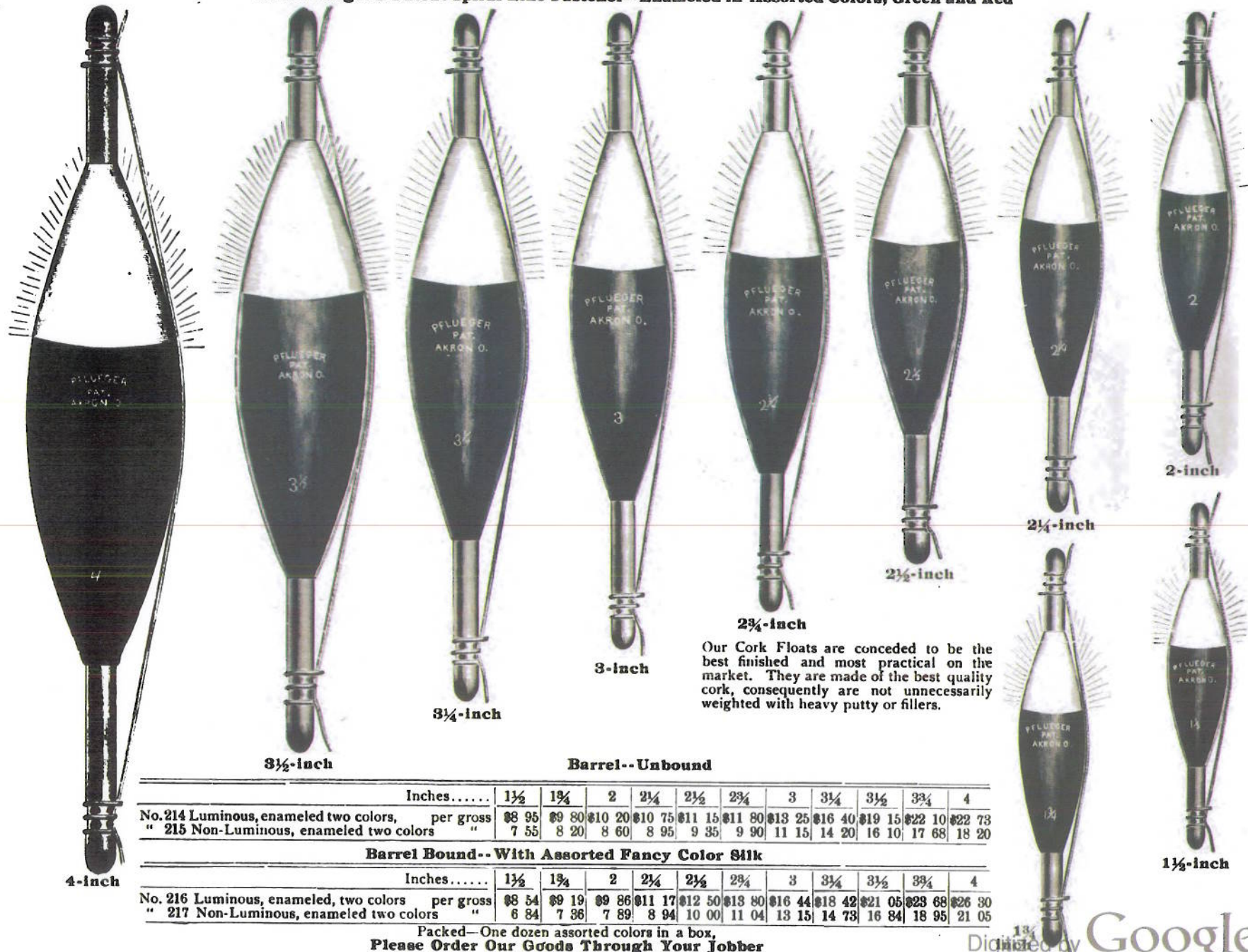

Our Cork Floats are conceded to be the best finished and most practical on the market. They are made of the best quality cork, consequently are not unnecessarily weighted with heavy putty or fillers.

		Barrel--Unbound											
		Inches.....											
		1½	1¾	2	2¼	2½	2¾	3	3¼	3½	3¾	4	
No. 214 Luminous, enameled two colors,	per gross	\$8 95	\$9 80	\$10 20	\$10 75	\$11 15	\$11 80	\$13 25	\$16 40	\$19 15	\$22 10	\$22 73	
" 215 Non-Luminous, enameled two colors "	"	7 55	8 20	8 60	8 95	9 35	9 90	11 15	14 20	16 10	17 68	18 20	
		Barrel Bound--With Assorted Fancy Color Silk											
		Inches.....											
		1½	1¾	2	2¼	2½	2¾	3	3¼	3½	3¾	4	
No. 216 Luminous, enameled, two colors	per gross	\$8 54	\$9 19	\$9 86	\$11 17	\$12 50	\$13 80	\$16 44	\$18 42	\$21 05	\$23 68	\$26 30	
" 217 Non-Luminous, enameled two colors "	"	8 84	7 36	7 89	8 94	10 00	11 04	13 15	14 73	16 84	18 95	21 05	

Packed--One dozen assorted colors in a box,
Please Order Our Goods Through Your Jobber

PFLUEGER'S SUPERFINE QUILL TOP CORK FLOATS

Painted in Assorted Colors, Green and Red

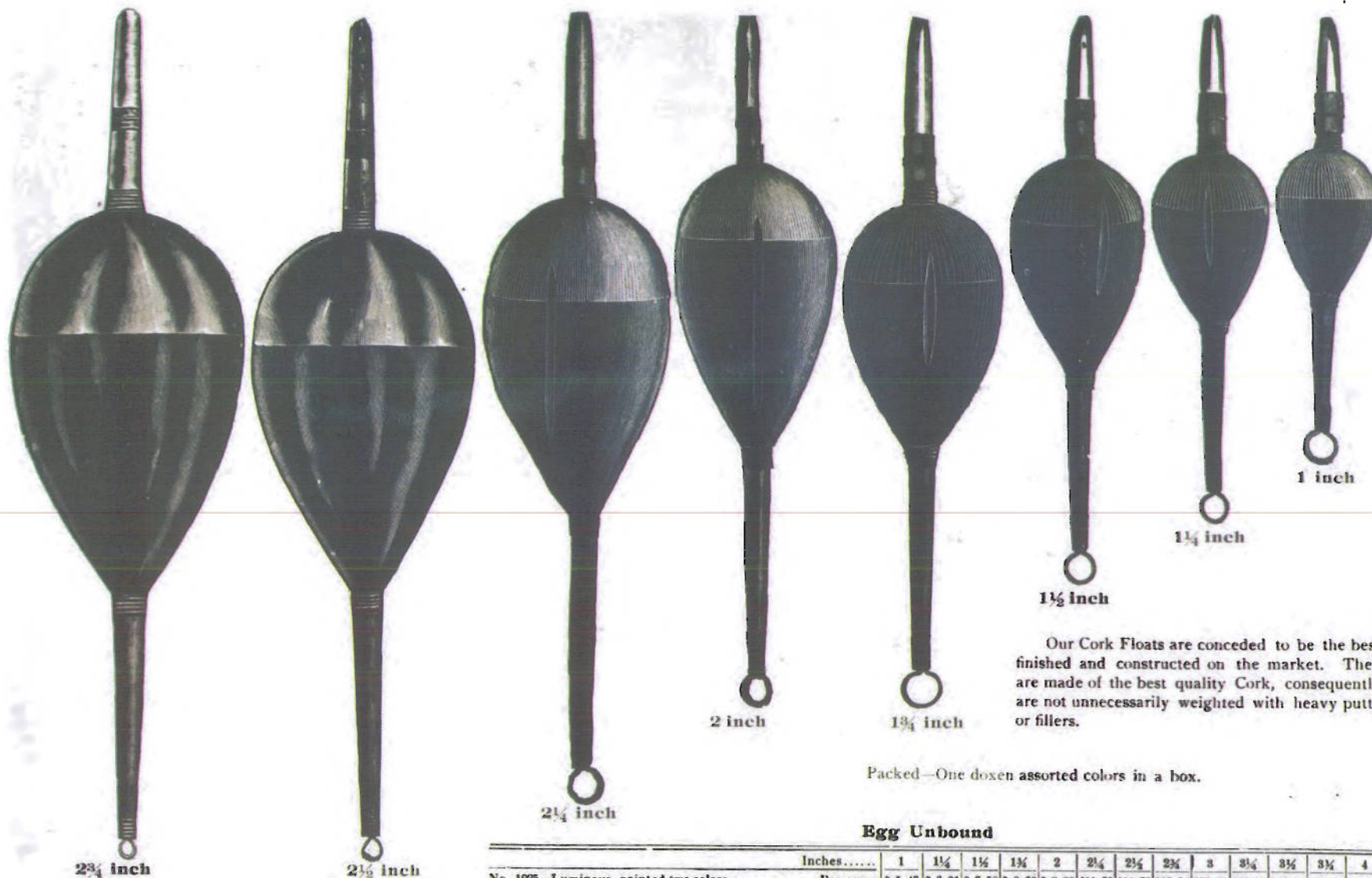

Our Cork Floats are conceded to be the best finished and constructed on the market. They are made of the best quality Cork, consequently are not unnecessarily weighted with heavy putty or fillers.

Packed—One dozen assorted colors in a box.

Egg Unbound

	Inches.....	1	1 1/4	1 1/2	1 3/4	2	2 1/4	2 1/2	2 3/4	3	3 1/4	3 1/2	3 3/4	4
No. 1025—Luminous, painted two colors.....	Per gross	\$ 5 47	\$ 6 31	\$ 7 58	\$ 8 68	\$ 9 80	\$11 79	\$15 79	\$18 94	\$22 81	\$26 81	\$32 84	\$36 84	\$42 73
No. 1026—Non-Luminous, painted two colors.....	Per gross	4 42	5 05	6 10	6 95	7 89	9 47	12 68	15 15	17 89	21 05	26 31	29 47	34 20

Egg Bound—with Assorted Fancy Color Silk

	Inches.....	1	1 1/4	1 1/2	1 3/4	2	2 1/4	2 1/2	2 3/4	3	3 1/4	3 1/2	3 3/4	4
No. 1029—Luminous, painted two colors.....	Per gross	\$ 7 58	\$ 8 42	\$ 9 68	\$10 73	\$12 00	\$13 89	\$17 89	\$21 05	\$24 42	\$28 42	\$34 04	\$39 04	\$44 84
No. 1030—Non-Luminous, painted two colors.....	Per gross	6 10	6 74	7 70	8 68	9 87	11 18	14 31	16 84	19 58	22 78	27 98	31 49	35 88

Please Order Our Goods Through Your Jobber

PFLUEGER'S SUPERFINE QUILLED TOP CORK FLOATS

Painted in Assorted Colors, Green and Red

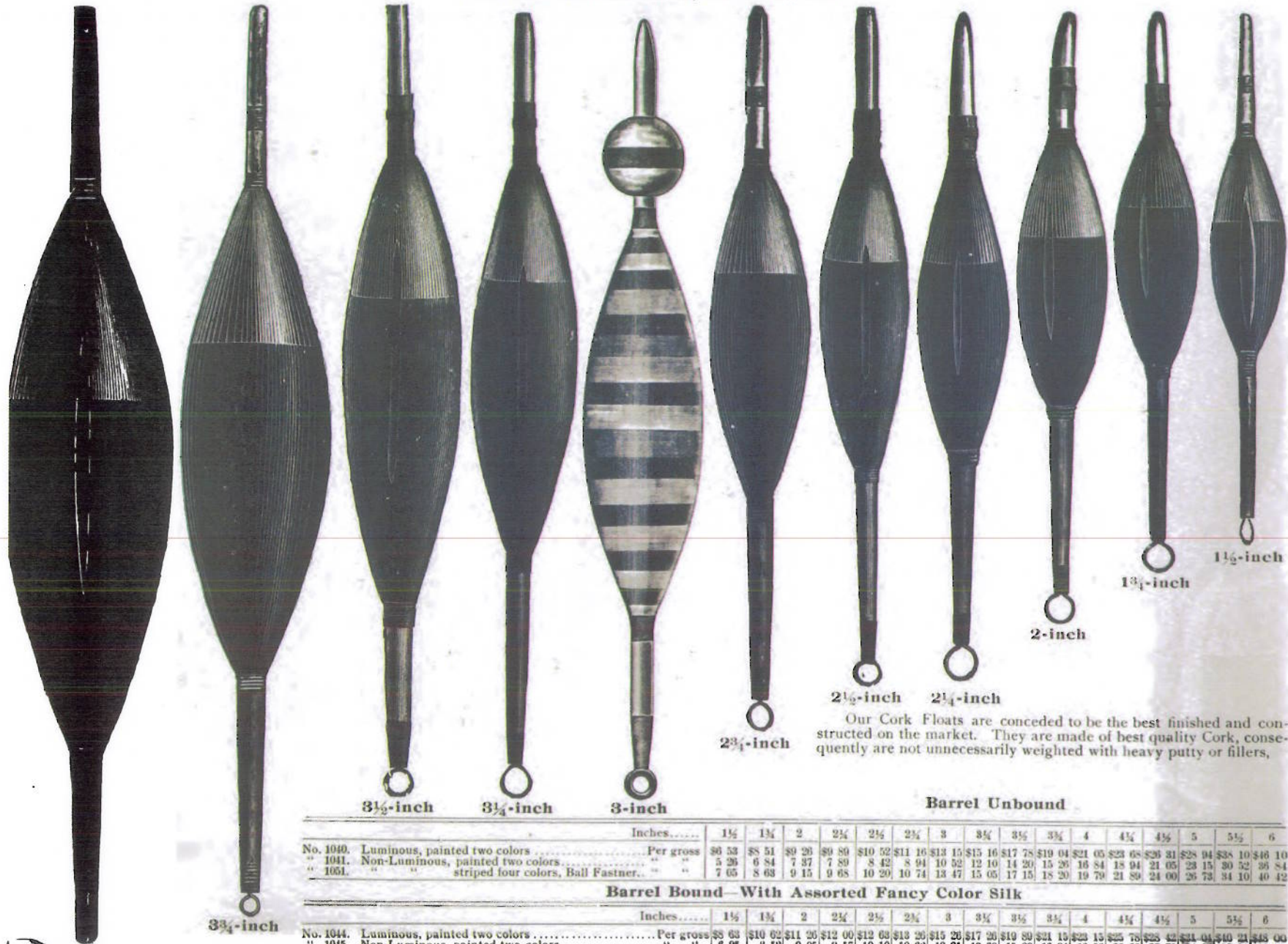

Our Cork Floats are conceded to be the best finished and constructed on the market. They are made of best quality Cork, consequently are not unnecessarily weighted with heavy putty or fillers,

		Barrel Unbound															
		Inches.....															
		1 1/2	1 3/4	2	2 1/4	2 1/2	2 3/4	3	3 1/4	3 1/2	3 3/4	4	4 1/4	4 1/2	5	5 1/2	6
No. 1040.	Luminous, painted two colors..... Per gross	\$6 53	\$8 51	\$9 26	\$9 89	\$10 52	\$11 16	\$13 15	\$15 16	\$17 78	\$19 04	\$21 05	\$23 08	\$26 31	\$28 94	\$38 10	\$46 10
" 1041.	Non-Luminous, painted two colors..... " "	5 26	6 84	7 37	7 89	8 42	8 94	10 52	12 10	14 20	15 26	16 84	18 04	21 05	23 15	30 52	36 84
" 1051.	" " striped four colors, Ball Fastner..... " "	7 05	8 63	9 15	9 68	10 20	10 74	13 47	15 05	17 15	18 20	19 79	21 89	24 00	26 73	34 10	40 42
		Barrel Bound—With Assorted Fancy Color Silk															
		Inches.....															
		1 1/2	1 3/4	2	2 1/4	2 1/2	2 3/4	3	3 1/4	3 1/2	3 3/4	4	4 1/4	4 1/2	5	5 1/2	6
No. 1044.	Luminous, painted two colors..... Per gross	\$8 63	\$10 62	\$11 26	\$12 00	\$12 68	\$13 20	\$15 20	\$17 20	\$19 80	\$21 13	\$23 15	\$25 78	\$28 42	\$31 04	\$40 21	\$48 00
" 1045.	Non-Luminous, painted two colors..... " "	6 95	8 52	9 05	9 57	10 10	10 62	12 21	13 79	15 80	16 94	18 52	20 63	22 78	24 64	32 21	38 62
" 1050.	" " striped four colors, Ball Fastner..... " "	8 73	10 81	10 84	11 37	11 89	13 57	15 16	16 73	18 88	19 89	21 47	23 58	25 68	28 42	35 76	43 10

12 dozen assorted colors in a box.

Please Order Our Goods Through Your Jobber

PFLUEGER'S FINE QUILL FLOATS

PLAIN VARNISHED QUILL FLOAT



Exact Size No. 1651

FANCY SILK WRAPPED AND STRIPED QUILL FLOAT



Exact Size No. 1652

The above are made from select goose quill and light pine stick, are very buoyant and being quite attractive produce a most desirable effect for light fishing. Packed—Each float wrapped in tissue paper. One half gross floats packed in fancy box.

No. 1651 Quill Floats.....	Price per gross \$4 20
" 1652 " "	" " " 7 36

PFLUEGER'S SUPERFINE ADJUSTABLE WOOD FLOATS

With Pflueger's Patent Spiral Line Fastener.



Egg Size, 2 inch

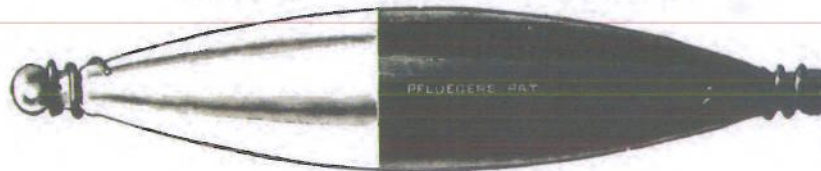

Barrel Size, 3 3/4 inch

Egg Shape

		Inches.....						
		1 1/2	1 3/4	2	2 1/4	2 1/2	2 3/4	3
No. 85 Luminous, Solid, Painted two colors.....	Per gross	\$3 80	\$4 10	\$4 65	\$5 45	\$5 90	\$6 50	\$7 25
" 85 Non-Luminous, Solid, Painted two colors.....	" "	3 05	3 25	3 70	4 40	4 75	5 25	5 80

Barrel Shape

		Inches.....					
		2 1/2	3	3 3/4	4	4 1/2	5
No. 86 Luminous, Solid, Painted two colors.....	Per gross	\$4 95	\$5 25	\$5 90	\$7 90	\$10 52	\$13 15
" 86 Non-Luminous, Solid, Painted, two colors	" "	4 00	4 20	4 75	6 30	8 40	10 52



Egg Size, 1 3/4 in

Packed—One dozen assorted colors in a box.

Please Order Our Goods Through Your Jobber

Pfueger's Single Action Reel Without Click

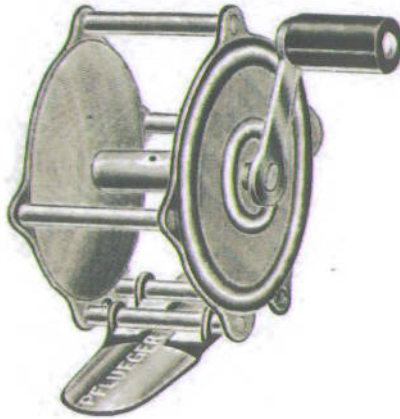

Brass	Per dozen	Polished Nickel Plate	Per dozen	Yards	Pillar	Disk
No. 1	\$1 20	No. 11	\$1 55	25	1 inch	1 3/4 in
" 2	1 36	" 12	1 78	40	1 inch	2 in
" 3	1 58	" 13	2 00	60	1 inch	2 1/4 in
" 4	1 89	" 14	2 24	80	1 inch	2 1/2 in
" 5	2 31	" 15	2 58	100	1 inch	2 3/4 in

Packed—One half dozen in a box

Pfueger's Single Action Flush Handle Reel With Click

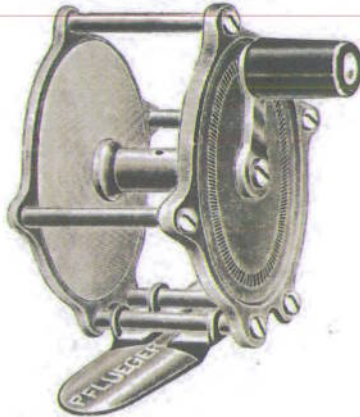

Polished Brass	Per dozen	Polished Nickel Plate	Per dozen	Yards	Pillar	Disk
No. 62	\$4 72	No. 72	\$5 46	40	1 inch	2 in
" 63	5 25	" 73	5 98	60	1 inch	2 1/4 in
" 64	5 77	" 74	6 51	80	1 inch	2 1/2 in
" 65	6 30	" 75	7 03	100	1 inch	2 3/4 in

Packed—One in a box

Pfueger's Single Action Reel With Click

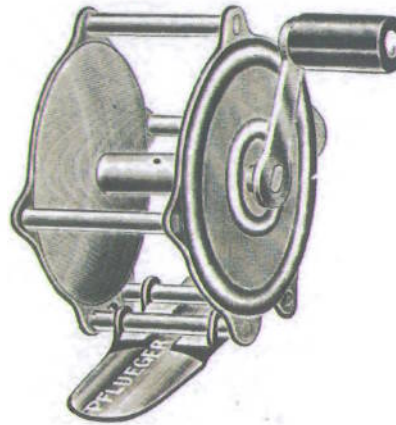

Brass	Per dozen	Polished Nickel Plate	Per dozen	Yards	Pillar	Disk
No. 21	\$1 47	No. 31	\$1 78	25	1 inch	1 3/4 in
" 22	1 72	" 32	2 00	40	1 inch	2 in
" 23	1 89	" 33	2 20	60	1 inch	2 1/4 in
" 24	2 10	" 34	2 42	80	1 inch	2 1/2 in
" 25	2 42	" 35	2 74	100	1 inch	2 3/4 in

Packed—One half dozen in a box

Pfueger's Single Action Flush Balanced Handle Reel With Back Sliding Click

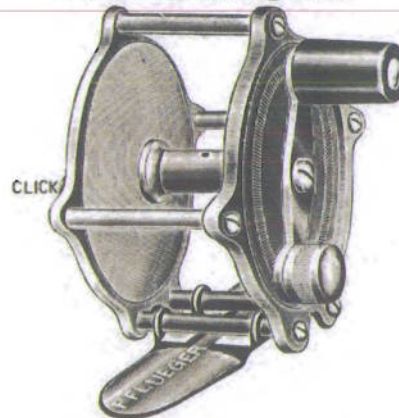

Polished Nickel Plate	Yards	Pillar	Disk	Per dozen
No. 82	40	1 inch	2 in	\$4 73
" 83	60	1 inch	2 1/4 in	5 26
" 84	80	1 inch	2 1/2 in	5 78
" 85	100	1 inch	2 3/4 in	6 73

Packed—One in a box

Please Order Our Goods Through Your Jobber

Pfueger's Single Action Reel With Click

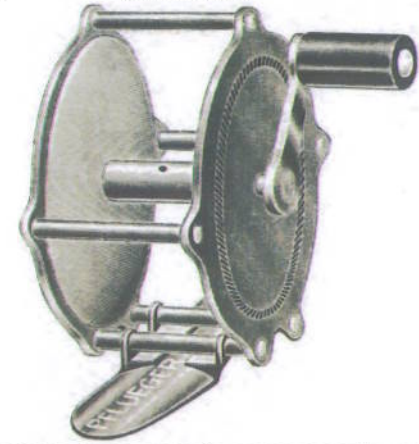

Polished Brass	Per dozen	Polished Nickel Plate	Per dozen	Yards	Pillar	Disk
No. 41	\$2 31	No. 51	\$3 04	25	1 inch	1 3/4 in
" 42	2 83	" 52	3 57	40	1 inch	2 in
" 43	3 48	" 53	4 20	60	1 inch	2 1/4 in
" 44	4 09	" 54	4 83	80	1 inch	2 1/2 in
" 45	4 72	" 55	5 46	100	1 inch	2 3/4 in

Packed—One half dozen in a box

Pfueger's Hard Rubber Single Action Reel With Click—Bushed Bearings

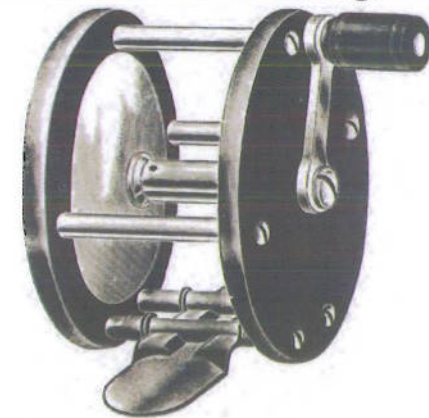

Polished Brass	Per dozen	Polished Nickel Plate	Per dozen	Yards	Pillar	Disk
No. 91	\$4 84	No. 101	\$5 26	25	1 inch	1 3/4 in
" 92	5 68	" 102	6 31	40	1 inch	2 in
" 93	6 42	" 103	6 84	60	1 inch	2 1/4 in
" 94	7 16	" 104	7 58	80	1 inch	2 1/2 in
" 95	7 58	" 105	8 06	100	1 inch	2 3/4 in

Packed—One in a box

PFLUEGER'S HARD RUBBER, SINGLE ACTION METAL BOUND REEL

Adjustable Back Sliding Click

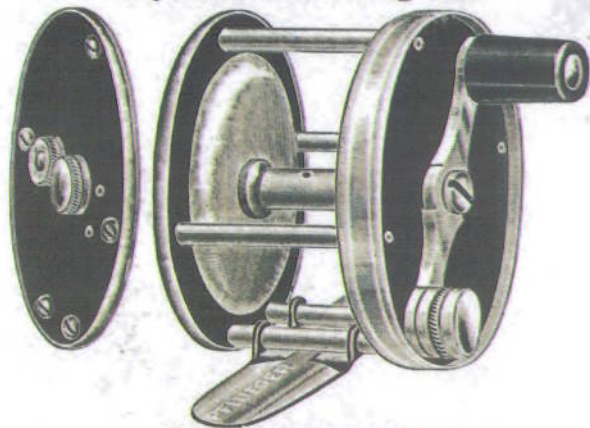

Polished Nickel Plate

No.	Yards	Pillar	Disk	Per Dozen
112	40	1 in. long	2 in. diam.	\$11 57
113	60	1 " "	2 1/4 " "	12 63
114	80	1 1/8 " "	2 1/2 " "	14 20
115	100	1 3/4 " "	2 3/4 " "	16 31

Packed—One in a box.

PFLUEGER'S ROUND PLATE, RUBBER CAP, MULTIPLYING REEL

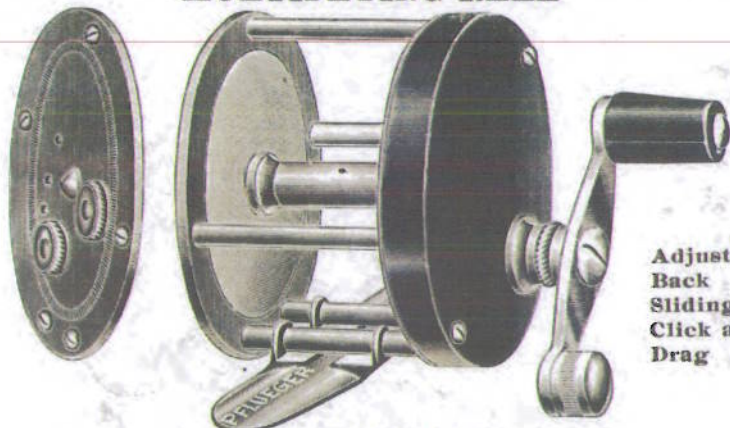

Adjustable Back Sliding Click and Drag

Polished Nickel Plate

No.	Yards	Pillar	Disk	Per Dozen
142	40	1 3/8 in. long	2 in. Diam.	\$11 57
143	60	1 3/8 " "	2 1/4 " "	12 10
144	80	1 3/8 " "	2 1/2 " "	12 63
145	100	1 3/8 " "	2 3/4 " "	13 15

Packed—One in a box.

PFLUEGER'S ROUND PLATE, MULTIPLYING REEL

Adjustable Back Sliding Click and Drag

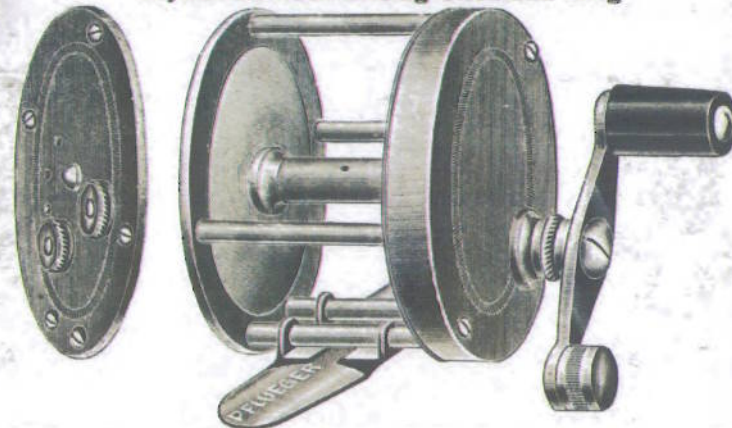

Polished Brass	Per Dozen	Polished Nickel Plate	Per Dozen	Yards	Pillar	Disk
No. 122	\$ 7 89	No. 132	\$ 8 42	40	1 3/8 Inch	2 Inch
" 123	8 52	" 133	9 05	60	1 3/8 " "	2 1/4 " "
" 124	8 94	" 134	9 47	80	1 3/8 " "	2 1/2 " "
" 125	10 00	" 135	10 52	100	1 3/8 " "	2 3/4 " "

Packed—One in a box.

PFLUEGER'S ROUND PLATE, MULTIPLYING REEL

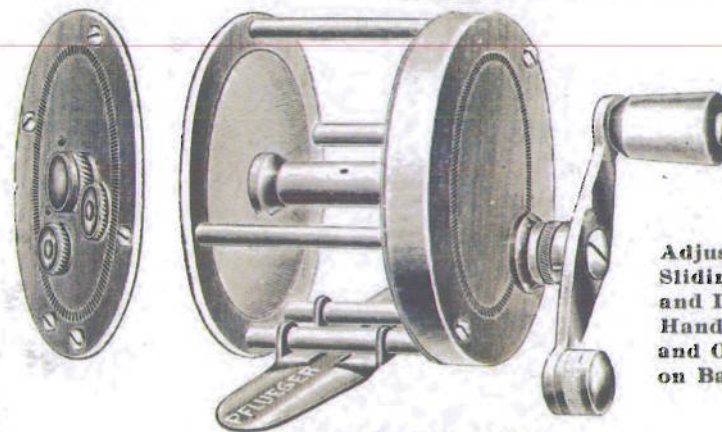

Adjustable Back Sliding Click and Drag, White Handle, Bushing and Oil Cup on Back Plate

Polished Nickel Plate

No.	Yards	Pillar	Disk	Per Dozen
532	40	1 3/8 in. long	2 in. Diam.	\$10 00
533	60	1 3/8 " "	2 1/4 " "	10 63
534	80	1 3/8 " "	2 1/2 " "	11 05
535	100	1 3/8 " "	2 3/4 " "	12 10

Packed—One in a box.

Please Order Our Goods Through Your Jobber

PFLUEGER'S RAISED PILLAR MULTIPLYING REEL

Adjustable Back Sliding Click and Drag

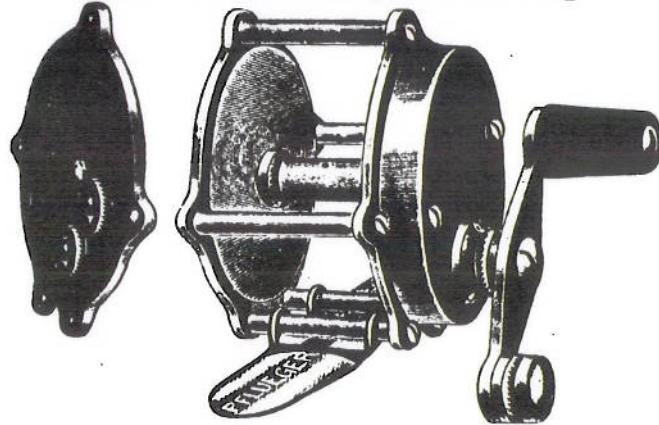

Polished Brass	Per Dozen	Polished Nickel Plate	Per Doz.	Yards	Pillar	Disk
No. 152	\$ 4 73	No. 162	\$ 5 36	40	1 inch	2 inch
" 153	5 26	" 163	5 78	60	1 "	2 1/4 "
" 154	5 58	" 164	6 84	80	1 1/8 "	2 1/2 "
" 155	6 84	" 165	8 10	100	1 1/4 "	2 3/4 "
" 156	8 42	" 166	8 94	150	1 1/2 "	3 "

Packed—One in a box.

PFLUEGER'S RAISED PILLAR MULTIPLYING REEL

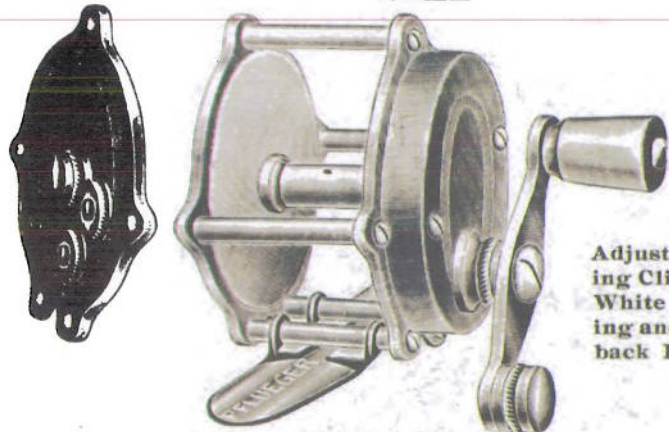

Adjustable Back Sliding Click and Drag
White Handle, Bushing and Oil Cup on back Plate

Polished Nickel Plate

No.	Yards	Pillar	Disk	Per Dozen
562	40	1 in. long	2 in. diam.	\$ 6 95
563	60	1 "	2 1/4 "	7 37
564	80	1 1/8 "	2 1/2 "	8 42
565	100	1 1/4 "	2 3/4 "	9 68
566	150	1 1/2 "	3 "	10 52

Packed—One in a box.

PFLUEGER'S RAISED PILLAR, RUBBER CAP, MULTIPLYING REEL

Adjustable Back Sliding Click and Drag

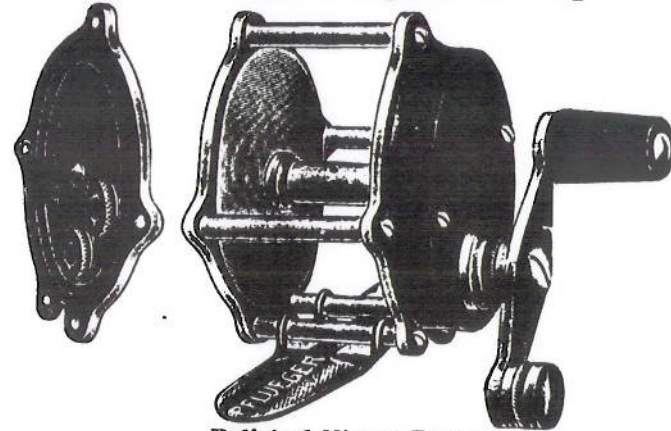

Polished Nickel Plate

No.	Yards	Pillar	Disk	Per Dozen
172	40	1 in. long	2 in. diam.	\$ 6 82
173	60	1 "	2 1/4 "	7 35
174	80	1 1/8 "	2 1/2 "	7 87
175	100	1 1/4 "	2 3/4 "	8 42
176	150	1 1/2 "	3 "	9 08

Packed—One in a box.

PFLUEGER'S FINE QUALITY RAISED PILLAR MULTIPLYING REEL

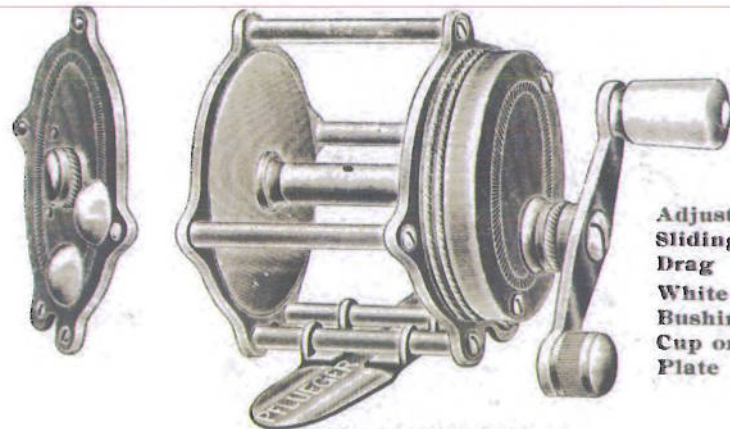

Adjustable Back Sliding Click and Drag
White handle, Bushing with Oil Cup on back Plate

Polished Nickel Plate

No.	Yards	Pillar	Disk	Per Dozen
182	40	1 3/8 in. long	2 in. diam.	\$ 11 68
183	60	1 3/8 "	2 1/4 "	12 10
184	80	1 3/8 "	2 1/2 "	13 78
185	100	1 3/8 "	2 3/4 "	15 68
186	150	1 3/8 "	3 "	17 26

Packed—One in a box.

Please Order Our Goods Through Your Jobber

PFLUEGER'S FINE QUALITY RAISED PILLAR QUADRUPLE REEL

Adjustable Back Sliding Click and Drag

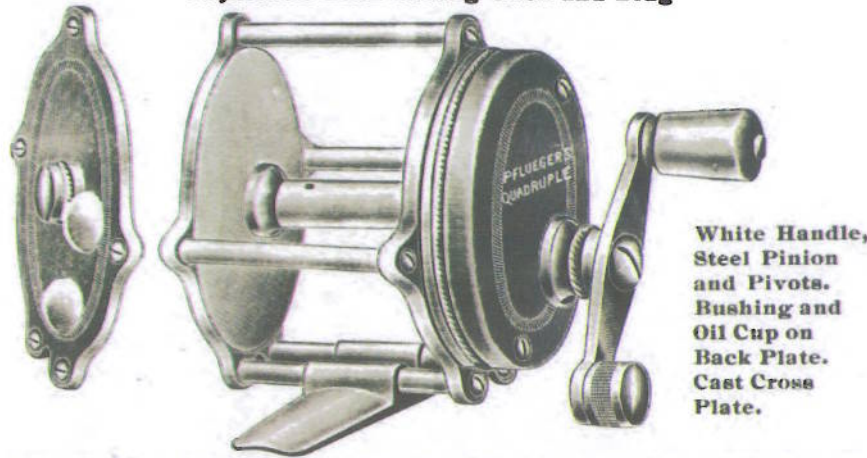

White Handle, Steel Pinion and Pivots. Bushing and Oil Cup on Back Plate. Cast Cross Plate.

No.	Yards.	Pillar	Disk	Per Dozen
503	60	1 3/8 in. long	2 1/4 in. diam.	\$13 68
504	80	1 3/8 "	2 1/2 "	15 79
505	100	1 3/8 "	2 3/4 "	17 90
506	150	1 3/8 "	3 "	20 00

Packed—One in a box.

PFLUEGER'S ROUND, WIDE PATTERN QUADRUPLE REEL

Back Sliding Click and Drag

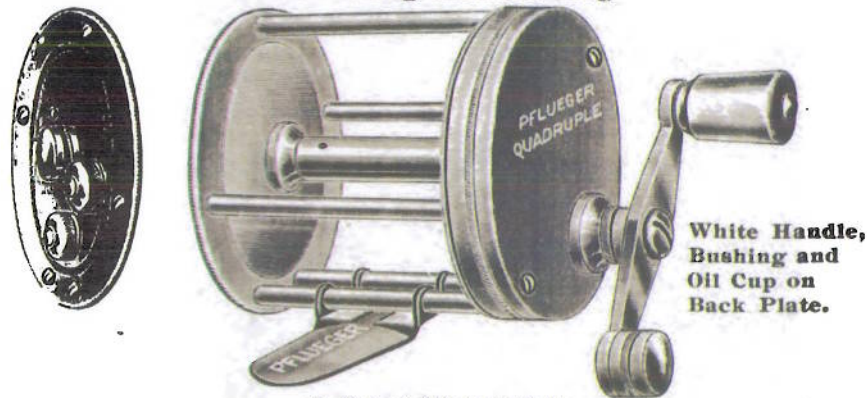

White Handle, Bushing and Oil Cup on Back Plate.

Polished Nickel Plate

No.	Yards	Pillar	Disk	Per Dozen
512	40	1 5/8 in. long.	1 3/4 in. diam.	\$10 52
513	60	1 5/8 "	2 "	11 58
514	80	1 5/8 "	2 1/4 "	12 63
515	100	1 5/8 "	2 1/2 "	13 68

Packed—One in a box.

Please Order Our Goods Through Your Jobber

PFLUEGER'S FINE QUALITY RAISED PILLAR QUADRUPLE REEL

Adjustable Back Sliding Click and Drag

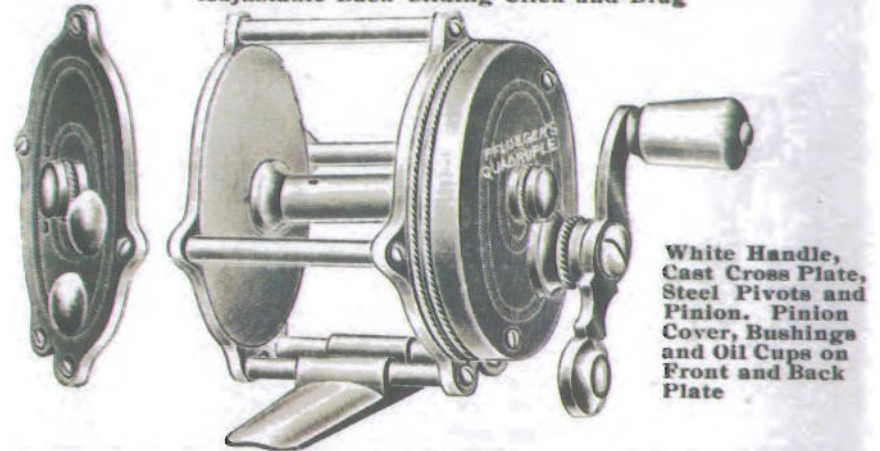

White Handle, Cast Cross Plate, Steel Pivots and Pinion. Pinion Cover, Bushings and Oil Cups on Front and Back Plate

Polished Nickel Plate	Per Doz.	Polished German Silver	Per Doz.	Yards	Pillar	Disk
No. 203	\$22 84	No. 233	\$52 62	60	1 3/8 inch	2 1/4 inch
" 204	24 94	" 234	56 83	80	1 3/8 "	2 1/2 "
" 205	26 73	" 235	61 04	100	1 3/8 "	2 3/4 "
" 206	28 94	" 236	65 25	150	1 3/8 "	3 "

Packed—One in a box.

PFLUEGER'S ROUND PATTERN QUADRUPLE REEL

Back Sliding Click and Drag

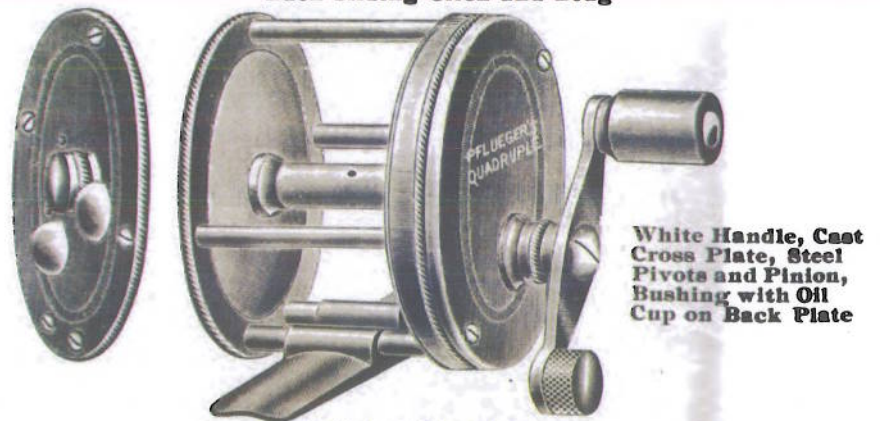

White Handle, Cast Cross Plate, Steel Pivots and Pinion, Bushing with Oil Cup on Back Plate

Polished Nickel Plate

No.	Yards	Pillar	Disk	Per Dozen
242	40	1 3/8 in. long.	2 in. diam.	\$14 52
243	60	1 3/8 "	2 1/4 "	16 63
244	80	1 3/8 "	2 1/2 "	18 73
245	100	1 3/8 "	2 3/4 "	20 84

Packed—One in a box.

PFLUEGER'S ROUND, WIDE PATTERN, QUADRUPLE REEL

Back Sliding Click and Drag

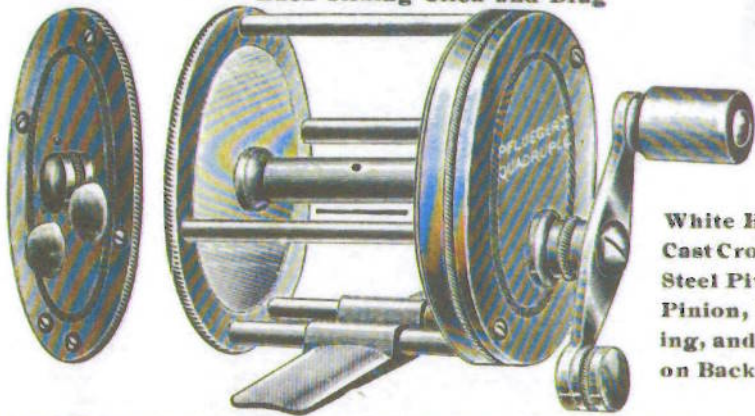

White Handle, Cast Cross Plate, Steel Pivots and Pinion, Bushing, and Oil Cup on Back Plate

	Yards	Pillar	Disk	Per Doz.
No. 542	40	1 5/8 in. long	2 in. Diam.	\$16 63
" 543	60	1 5/8 "	2 1/4 "	18 74
" 544	80	1 5/8 "	2 1/2 "	20 84
" 545	100	1 5/8 "	2 3/4 "	22 94

Packed—One in a box.

PFLUEGER'S FINE QUALITY, ROUND, WIDE PATTERN QUADRUPLE REEL

Adjustable Back Sliding Click and Drag

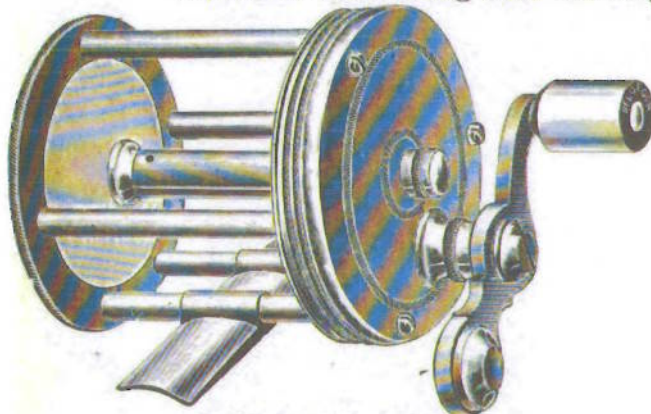

White Handle, Cast Cross Plate, Steel Pinion and Pivots, Pinion Cover, Bushings with Oil Cups on Front and Back Plate

Polished Nickel Plate

	Yards	Pillar	Disk	Per Doz.
No. 592	40	1 5/8 Inch	1 3/4 Inch	\$24 20
" 593	60	1 5/8 "	2 "	26 30
" 594	80	1 5/8 "	2 1/4 "	28 42
" 595	100	1 5/8 "	2 1/2 "	30 52

Packed—One in a box.

PFLUEGER'S FINE QUALITY, ROUND PATTERN, QUADRUPLE REEL

Adjustable Back Sliding Click and Drag

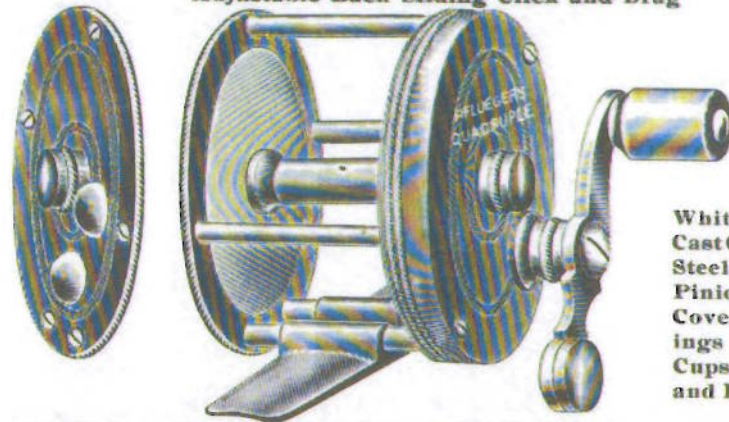

White Handle, Cast Cross Plate, Steel Pivots and Pinion Cover. Bushings With Oil Cups on Front and Back Plate

Polished Nickel Plate	Per Doz.	Polished German Silver	Per Doz.	Yards	Pillar	Disk
No. 192	\$22 10	No. 222	\$52 62	40	1 3/8 Inch	2 Inch
" 193	24 21	" 223	56 83	60	1 3/8 "	2 1/4 "
" 194	26 31	" 224	61 04	80	1 3/8 "	2 1/2 "
" 195	28 42	" 225	65 25	100	1 3/8 "	3 "

Packed—One in a box.

PFLUEGER'S ROUND, WIDE PATTERN, QUADRUPLE REEL

Adjustable Front Sliding Drag and Back Sliding Click With or Without Jewels in Oil Cups

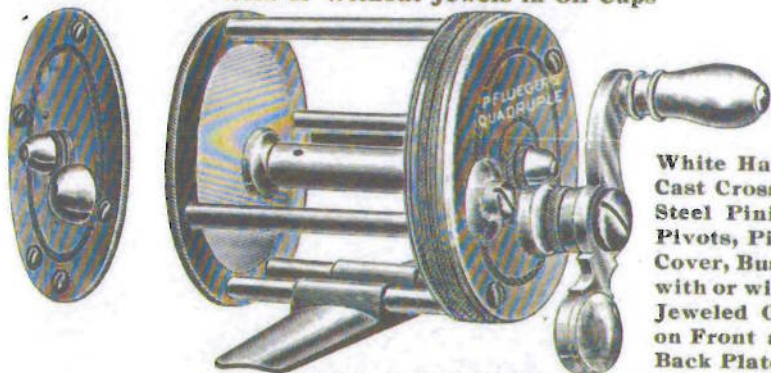

White Handle, Cast Cross Plate, Steel Pinion and Pivots, Pinion Cover, Bushings with or without Jeweled Oil Cups on Front and Back Plate

Polished Nickel Plate

With Jewels	Per Doz.	Without Jewels	Per Doz.	Yards	Pillar	Disk
No. 552	\$37 89	No. 552	\$25 26	40	1 5/8 Inch	1 3/4 in. diam.
" 553	40 00	" 553	27 36	60	1 5/8 "	2 "
" 554	42 10	" 554	29 48	80	1 5/8 "	2 1/4 "
" 555	44 20	" 555	31 58	100	1 5/8 "	2 1/2 "

Packed—One in a box.

Please Order Our Goods Through Your Jobber



PFLUEGER'S FANCY RUBBER, ROUND PATTERN MULTIPLYING REEL

Adjustable Back Sliding Click and Drag

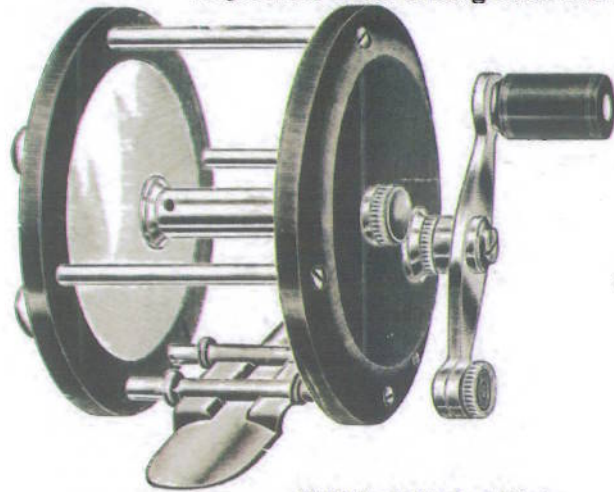

Bushings with Oil Cups on Front and Back plate

Polished Nickel Plate

No.	Yards	Pillar	Disk	Per Dozen
212	40	1 3/4 in. long	2 in. diam.	\$15 26
213	60	1 3/8 "	2 1/4 "	16 31
214	80	1 3/4 "	2 1/2 "	17 90
215	100	1 3/8 "	2 3/4 "	20 00

Packed—One in a box.

PFLUEGER'S FANCY RUBBER, ROUND WIDE PATTERN QUADRUPLE REEL

Adjustable Back Sliding Click and Drag

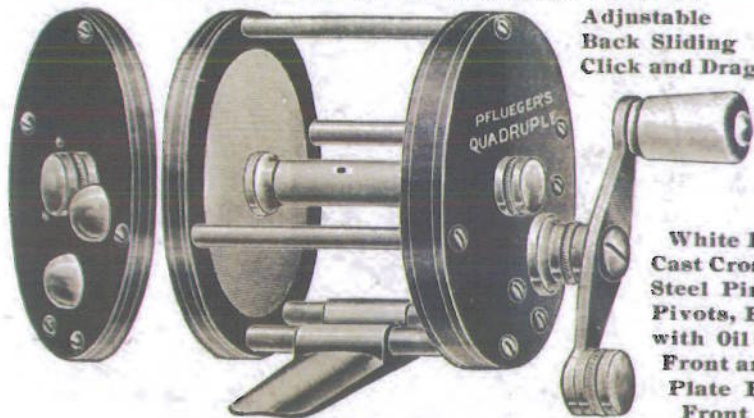

White Handle, Cast Cross Plate, Steel Pinion and Pivots, Bushings with Oil Cups, on Front and Back Plate Bridged Front Plate

Polished Nickel Plate

No.	Yards	Pillar	Disk	Per Dozen
493	60	1 5/8 in. long	2 in. diam.	\$21 57
494	80	1 5/8 "	2 1/4 "	23 15
495	100	1 5/8 "	2 1/2 "	25 26
496	150	1 5/8 "	2 3/4 "	28 42

Packed—One in a box

PFLUEGER'S FANCY RUBBER, ROUND PATTERN MULTIPLYING REEL

Adjustable Back Sliding Click and Drag

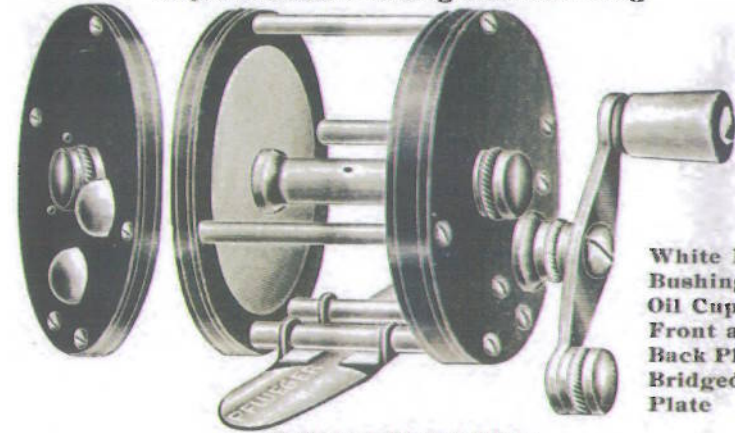

White Handle, Bushings with Oil Cups, on Front and Back Plate Bridged Front Plate

Polished Nickel Plate

No.	Yards	Pillar	Disk	Per Dozen
482	40	1 3/4 in. long	2 in. diam.	\$16 84
483	60	1 3/8 "	2 1/4 "	17 26
484	80	1 3/4 "	2 1/2 "	18 10
485	100	1 3/8 "	2 3/4 "	19 79
486	150	1 3/8 "	3 "	23 15

Packed—One in a box.

PFLUEGER'S SINGLE ACTION RUBBER, GERMAN SILVER BOUND REEL

Adjustable Back Sliding Click

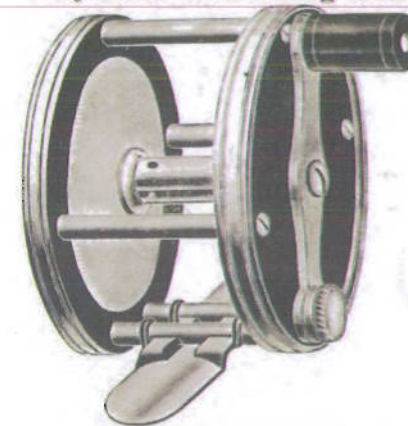

A Strictly High Grade Trout Reel. Strong, Light and Easy Running

Polished German Silver

No.	Yards	Pillar	Disk	Per Dozen
262	40	1 in. long	2 in. diam.	\$33 68
263	60	1 "	2 1/4 "	37 89
264	80	1 1/4 "	2 1/2 "	42 10
265	100	1 1/2 "	2 3/4 "	46 31
266	150	1 3/4 "	3 "	50 62

Packed—One in a box.

Please Order Our Goods Through Your Jobber

PFLUEGER'S EXTRA QUALITY RAISED PILLAR, INLAID RUBBER, MULTIPLYING REEL

Extra Wide Pattern, Back Sliding Click

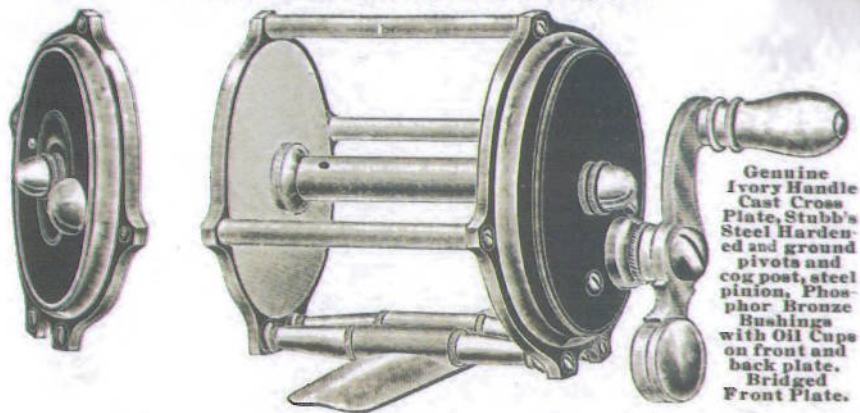

Genuine Ivory Handle
Cast Cross Plate, Stubb's Steel Hardened and ground pivots and cog post, steel pinion, Phosphor Bronze Bushings with Oil Cups on front and back plate. Bridged Front Plate.

	Hand Polished German Silver	Yards	Pillar	Disk	Price Each
No. 283	60	17 $\frac{1}{8}$ in. long	2 in. diam	\$21 05
" 284	80	17 $\frac{1}{8}$ in. long	2 $\frac{1}{4}$ in. diam	25 26
" 285	100	17 $\frac{1}{8}$ in. long	2 $\frac{3}{8}$ in. diam	31 57

Packed—One in a box.

PFLUEGER'S EXTRA QUALITY RAISED PILLAR, INLAID RUBBER, QUADRUPLE REEL

Extra Wide Pattern, Back Sliding Click

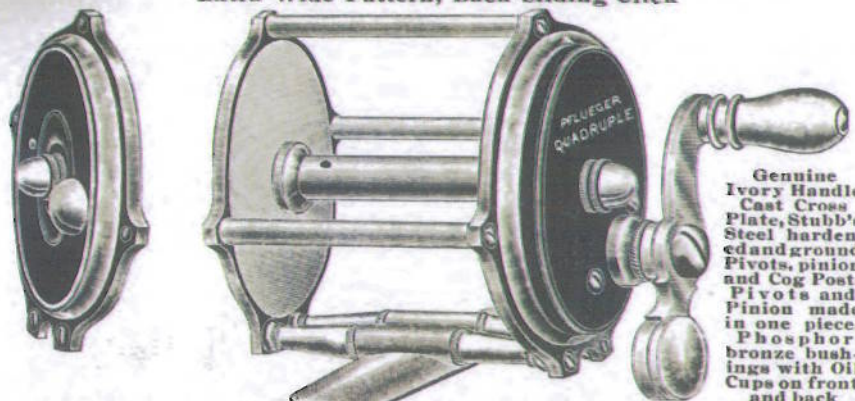

Genuine Ivory Handle
Cast Cross Plate, Stubb's Steel hardened and ground Pivots, pinion and Cog Post. Pivots and Pinion made in one piece. Phosphor bronze bushings with Oil Cups on front and back plate. Bridged front plate

This Reel is built as fine and accurate as possible. Pivots run in fine Steel Dead Centers

	Hand Polished German Silver	Yards	Pillar	Disk	Price Each
No. 293	60	17 $\frac{1}{8}$ in long	2 in. diam	\$25 26
" 294	80	17 $\frac{1}{8}$ in long	2 $\frac{1}{4}$ in. diam	29 47
" 295	100	17 $\frac{1}{8}$ in long	2 $\frac{3}{8}$ in. diam	35 79

Packed—One in a box.

PFLUEGER'S SINGLE ACTION, RAISED PILLAR, INLAID RUBBER REEL

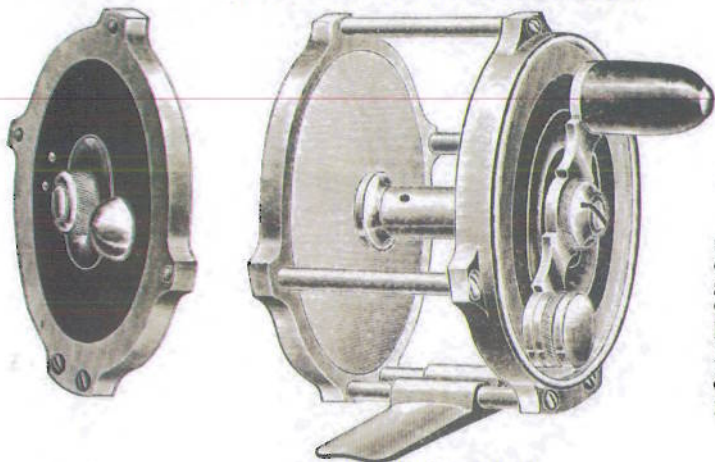

For Trout and Salmon
Steel Hardened and ground pivots, Phosphor bronze bushed with oil cup on back plates

Back Sliding Click

	Hand Polished German Silver	Yards	Pillar	Disk	Per Dozen
No. 273	60	11 $\frac{1}{8}$ inch	2 $\frac{1}{4}$ inch	\$ 63 15
" 274	80	11 $\frac{1}{8}$ inch	2 $\frac{3}{8}$ inch	69 46
" 275	100	11 $\frac{1}{4}$ inch	2 $\frac{3}{4}$ inch	75 78
" 276	150	11 $\frac{1}{4}$ inch	3 inch	105 25
" 277	200	13 $\frac{1}{8}$ inch	3 $\frac{1}{4}$ inch	134 72

Packed—One in a box.

Please Order Our Goods Through Your Jobber

PFLUEGER'S FINE QUALITY RUBBER, METAL BOUND, MULTIPLYING REEL

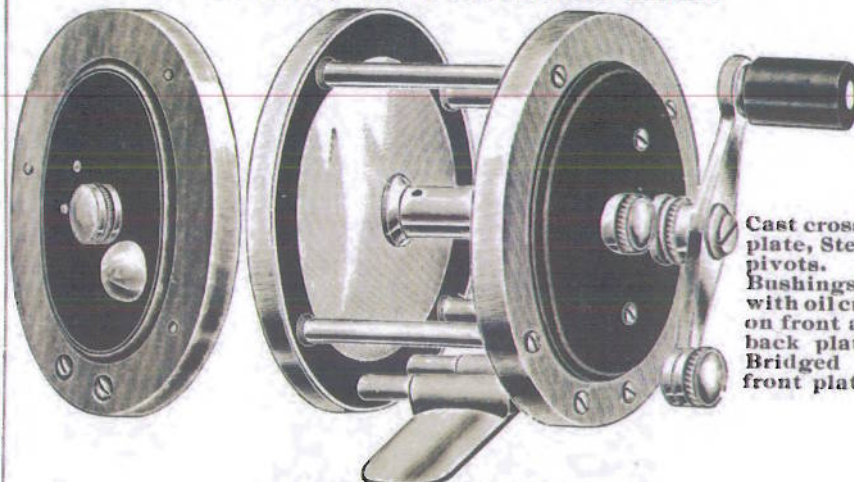

Cast cross plate, Steel pivots. Bushings with oil cups on front and back plate. Bridged front plate

Adjustable Back Sliding Click

	Polished Nickel Plate	Per Dozen	Polished German Silver	Per Dozen	Yards	Pillar	Disk
No. 302	\$35 78	No. 312	\$ 52 63	40	13 $\frac{1}{8}$ inch 2 inch
" 303	38 93	" 313	63 15	60	13 $\frac{1}{8}$ inch 2 $\frac{1}{4}$ inch
" 304	43 15	" 314	84 20	80	13 $\frac{1}{8}$ inch 2 $\frac{3}{8}$ inch
" 305	48 42	" 315	103 15	100	17 $\frac{1}{8}$ inch 2 $\frac{3}{4}$ inch

Packed—One in a box.

Pflueger's Extra Quality Reel

Round Rubber, Metal Bound, Quadruple, Wide Pattern, Back Sliding Click

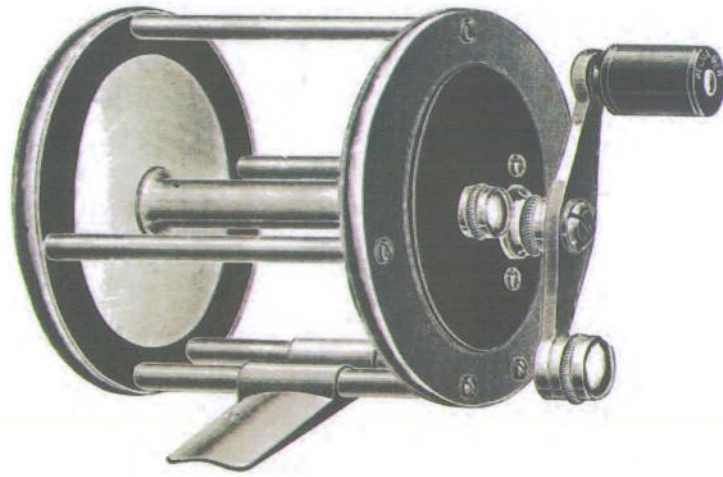

Steel Cog Post, Pivots and Pinions, Bushings with oil cups on front and back plate.

Cast cross plate, Bridged Front Plate.

A High Grade Reel, light, yet very durable.

Made in Polished Nickel, and Solid German Silver,

Polished Nickel Plate	Per Dozen	Polished German Silver	Per Dozen	Yards	Pillar	Disk
No. 323	\$ 42 10	No. 333	\$ 67 36	60	1 $\frac{5}{8}$ inch	2 inch.
" 324	46 31	" 334	88 41	80	1 $\frac{5}{8}$ "	2 $\frac{1}{4}$ "
" 325	50 52	" 335	107 35	100	1 $\frac{5}{8}$ "	2 $\frac{1}{2}$ "
" 326	54 73	" 336	130 52	150	1 $\frac{5}{8}$ "	2 $\frac{3}{4}$ "

Packed—One in a box.

Pflueger's Extra Quality Reel

Round Rubber, Metal Bound, Jewelled, Quadruple, Wide Pattern, Back Sliding Click

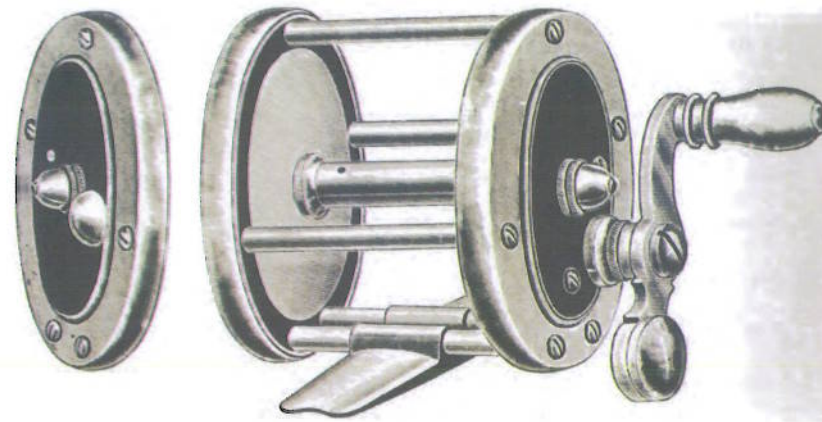

Steel Cog Post, Pivots and Pinion, bushings with Jewelled Oil Cups on front and back Plate.

Cast cross plate, Bridged Front Plate.

White Handle.

This is an elegant Reel. Light, yet very durable.

Made in Polished Nickel and Solid German Silver.

Polished Nickel Plate	Per Dozen	Polished German Silver	Per Dozen	Yards	Pillar	Disk
No. 523	\$ 57 89	No. 633	\$ 83 15	60	1 $\frac{5}{8}$ inch	2 inch
" 524	62 10	" 634	104 20	80	1 $\frac{5}{8}$ "	2 $\frac{1}{4}$ "
" 525	66 31	" 635	125 25	100	1 $\frac{5}{8}$ "	2 $\frac{1}{2}$ "
" 526	70 52	" 636	146 30	150	1 $\frac{5}{8}$ "	2 $\frac{3}{4}$ "

Packed—One in a box.

Please Order Our Goods Through Your Jobber

PFLUEGER'S SUMMIT REEL

Raised Pillar, Wide Pattern, Quadruple, Front Sliding
Click and Drag

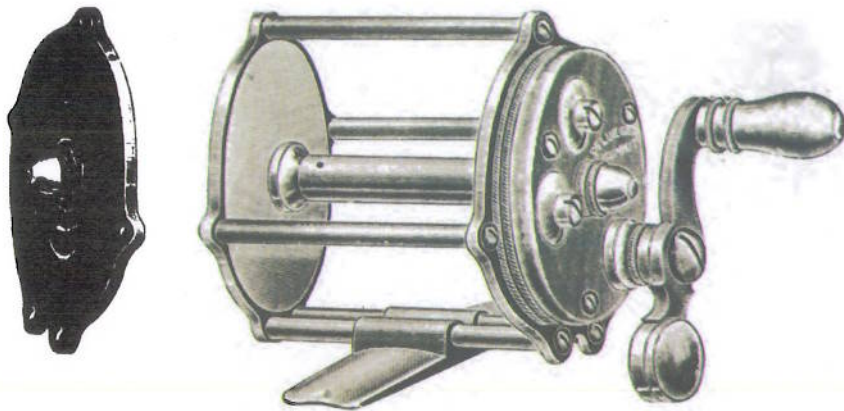

Pinion, Pivots and Cog Post made of Steel.
Cross Plate Kentucky Pattern.
White Handle, Fancy Balanced Crank.
Made with and without Jewels in Oil Cups.

Polished Nickel Plate

With Jewel	Per Dozen	Without Jewel	Per Dozen	Yards	Pillar	Diak
No. 473]	\$52 63	No. 473	\$40 00	60	1 $\frac{7}{8}$ inch	2 inch
" 474]	54 73	" 474	42 10	80	1 $\frac{7}{8}$ "	2 $\frac{1}{4}$ "
" 475]	56 84	" 475	44 20	100	1 $\frac{7}{8}$ "	2 $\frac{1}{2}$ "

Packed—One in a box—three boxes in a carton

PFLUEGER'S BUCKEYE REEL

Round Wide Pattern, Quadruple, Front Sliding
Click and Drag

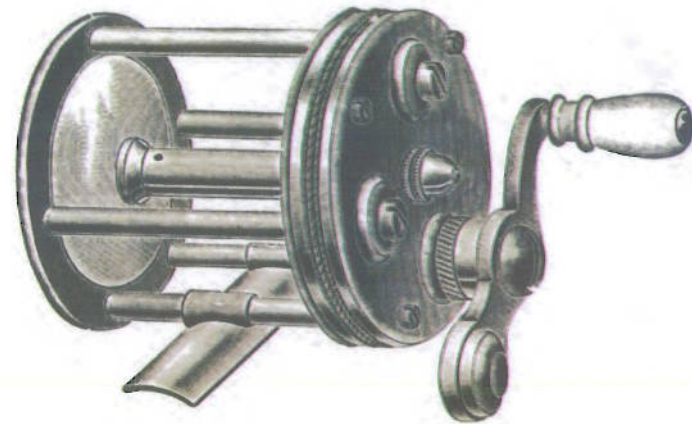

Pinion, Pivots and Cog Post, made of Steel.
Cross Plate Kentucky Pattern.
White Handle, Fancy Balanced Crank.
Made with and without Jewels in Oil Cups.

Polished Nickel Plate

With Jewel	Per Dozen	Without Jewel	Per Dozen	Yards	Pillar	Diak
No. 462]	\$50 52	No. 462	\$37 89	40	1 $\frac{7}{8}$ inch	1 $\frac{3}{4}$ inch
" 463]	52 63	" 463	40 00	60	1 $\frac{7}{8}$ "	2 "
" 464]	54 73	" 464	42 10	80	1 $\frac{7}{8}$ "	2 $\frac{1}{4}$ "
" 465]	56 84	" 465	44 20	100	1 $\frac{7}{8}$ "	2 $\frac{1}{2}$ "

Packed—One in a box—three boxes in a carton

We call especial attention to our Summit and Buckeye Reels. They are without a doubt the most modern and best constructed medium priced reels on the market.

If you have not seen them, send for sample.

Please Order Our Goods Through Your Jobber

PFLUEGER'S KENTUCKY REEL

Round, Wide Pattern, Quadruple, Front Sliding
Click and Drag

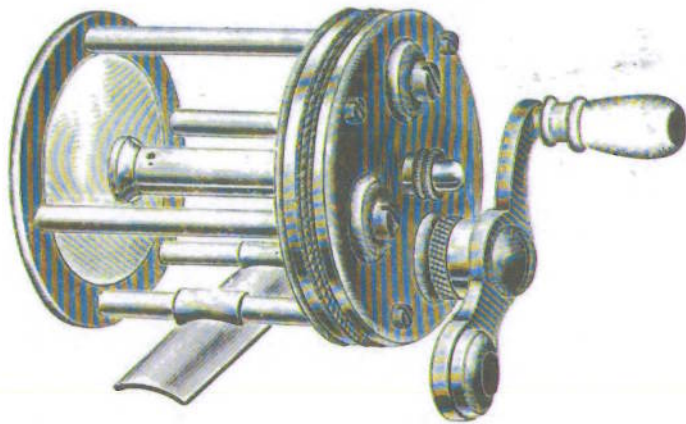

Pinion and Pivots in one piece, made of Stubb's Steel hardened and ground.

Cog Post, made from Stubb's Steel, hardened and ground.
Phosphor bronze Bushings with Fancy Oil Cups.

White Ivory Handle, Balanced Fancy Crank.

Made with or without Jewels.

Solid German Silver, Hand Polished.

With Jewels	Price Each	Without Jewels	Price Each	Yards	Pillar	Disk
No. 442]	\$11 58	No. 442	\$10 58	40	1 $\frac{7}{8}$ inch	1 $\frac{3}{4}$ inch
" 443]	13 68	" 443	12 68	60	1 $\frac{7}{8}$ "	2 "
" 444]	15 79	" 444	14 74	80	1 $\frac{7}{8}$ "	2 $\frac{1}{4}$ "
" 445]	17 89	" 445	16 84	100	1 $\frac{7}{8}$ "	2 $\frac{1}{2}$ "

The material and running qualities of this Reel are perfect. The adjustment very accurate.

An article that appeals to the Sportsman.

Packed—Each Reel in a Rich Black Leatheret Box, Gold Bronze Printed Label, and for protection, we put three of these boxes in a carton.

PFLUEGER'S AKRON REEL

Round, Wide Pattern, Quadruple, Front Sliding
Click and Drag

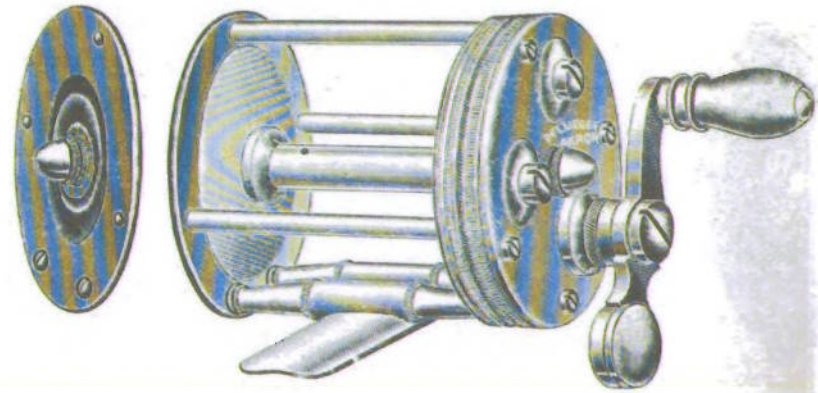

Pinion and Pivots cut in one piece from Stubb's Steel, hardened, ground and polished.

The Bushings are made from best Phosphor Bronze, having a dead center bearing of either Agate or German Silver, as ordered, and with Fancy Oil Cups.

Cog Post made from Stubb's Steel, polished and ground.

Genuine Ivory Handle.

Made with or without Jewel Bearings. When made with Jewel Bearings we use genuine Sapphire.

Solid German Silver, Hand Polished Satin Finish.

With Jewels	Price Each	Without Jewels	Price Each	Yards	Pillar	Disk
No. 422]	\$23 15	No. 422	\$18 94	40	1 $\frac{7}{8}$ inch	1 $\frac{3}{4}$ inch
" 423]	25 26	" 423	21 05	60	1 $\frac{7}{8}$ "	2 "
" 424]	29 47	" 424	25 26	80	1 $\frac{7}{8}$ "	2 $\frac{1}{4}$ "

This Reel is a product of the most skilled labor.

A strictly high grade, hand made article.

Packed—Each Reel in a Rich Black Leatheret Box, Gold Bronze Printed Label; and for protection, we put three of these boxes in a carton.

Please Order Our Goods Through Your Jobber

Pflueger's Salt Water Reel

Raised Pillar, Multiplying, Built Extra Strong with Back Sliding Click and Drag

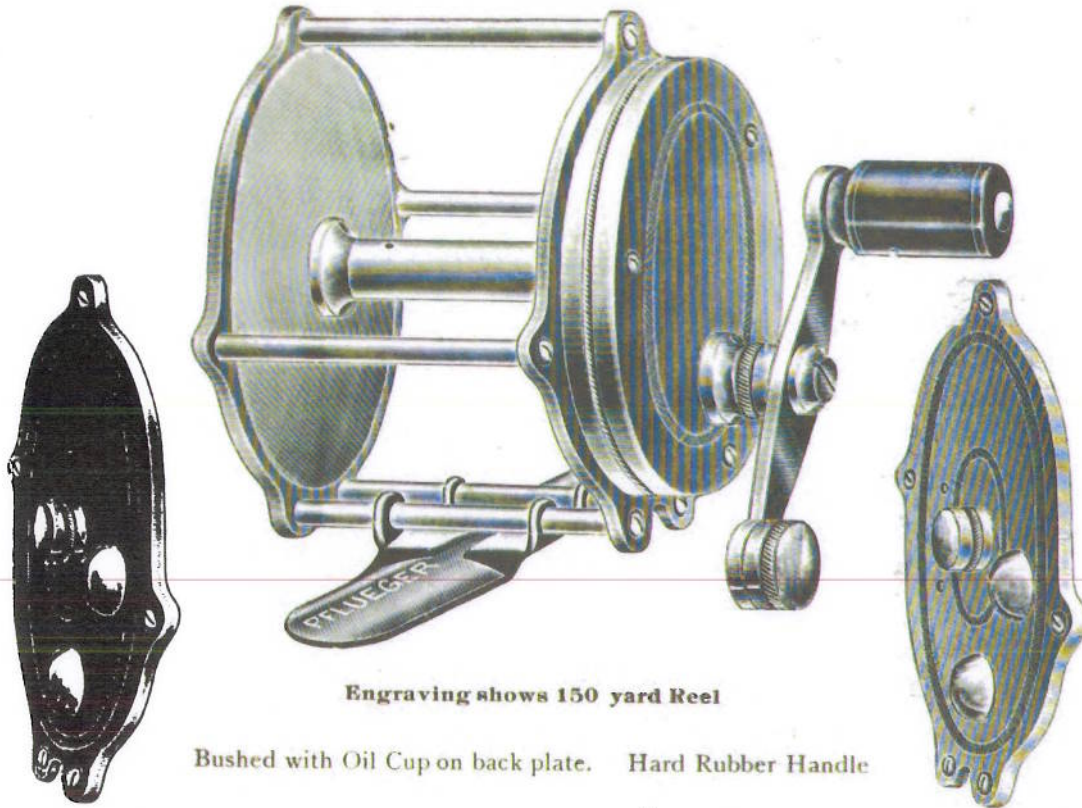

Engraving shows 150 yard Reel

Bushed with Oil Cup on back plate. Hard Rubber Handle

Pflueger's Salt Water Reel

Raised Pillar, Multiplying, Built Extra Strong with Back Sliding Click and Drag. Hard Rubber Cap

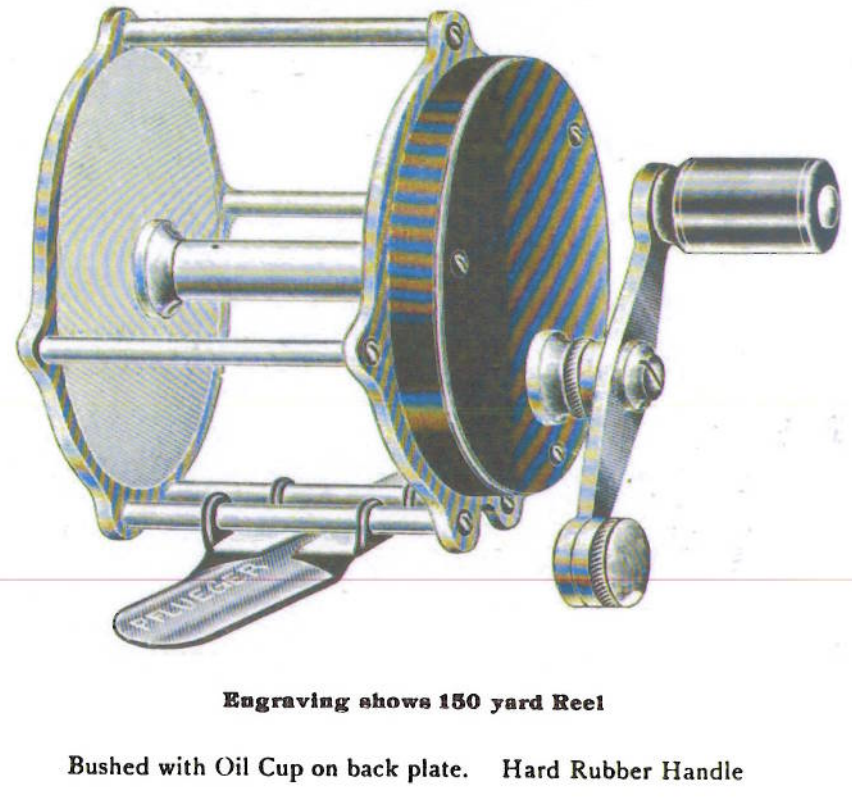

Engraving shows 150 yard Reel

Bushed with Oil Cup on back plate. Hard Rubber Handle

Polished Nickel Plate		Yards	Pillar	Disk	Per doz.
No. 346	150	1 $\frac{7}{8}$ in. long	3 in. diam	\$18 94
" 347	200	1 $\frac{7}{8}$ in. long	3 $\frac{1}{4}$ in. diam	21 05
" 348	250	1 $\frac{7}{8}$ in. long	3 $\frac{1}{2}$ in. diam	23 15
" 349	300	1 $\frac{7}{8}$ in. long	3 $\frac{3}{4}$ in. diam	25 58

Packed—One in a box.

Polished Nickel Plate		Yards	Pillar	Disk	Per doz.
No. 346R	150	1 $\frac{7}{8}$ in. long	3 in. diam	\$23 15
" 347R	200	1 $\frac{7}{8}$ in. long	3 $\frac{1}{4}$ in. diam	25 28
" 348R	250	1 $\frac{7}{8}$ in. long	3 $\frac{1}{2}$ in. diam	27 38
" 349R	300	1 $\frac{7}{8}$ in. long	3 $\frac{3}{4}$ in. diam	29 47

Packed—One in a box.

Please Order Our Goods Through Your Jobber

Pflueger's Salt Water Reel

Round, Multiplying, Adjustable Back Sliding
Click and Drag

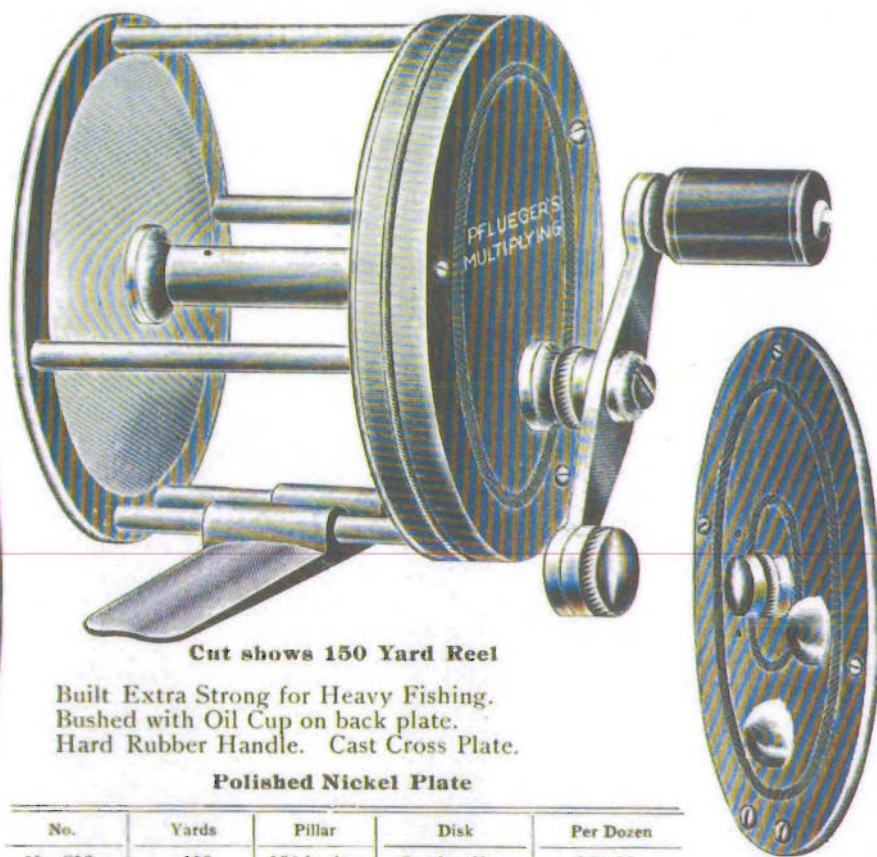

Cut shows 150 Yard Reel

Built Extra Strong for Heavy Fishing.
Bushed with Oil Cup on back plate.
Hard Rubber Handle. Cast Cross Plate.

Polished Nickel Plate

No.	Yards	Pillar	Disk	Per Dozen
No. 356	150	1 $\frac{7}{8}$ in. long	3 in. diam.	\$25 26
" 357	200	1 $\frac{7}{8}$ "	3 $\frac{1}{4}$ "	27 86
" 358	250	1 $\frac{7}{8}$ "	3 $\frac{1}{2}$ "	29 47
" 359	300	1 $\frac{7}{8}$ "	3 $\frac{3}{4}$ "	31 57

Packed—One in a box.

Pflueger's Salt Water Reel

Round, Multiplying, Adjustable Back Sliding Click and Drag,
Hard Rubber Cap

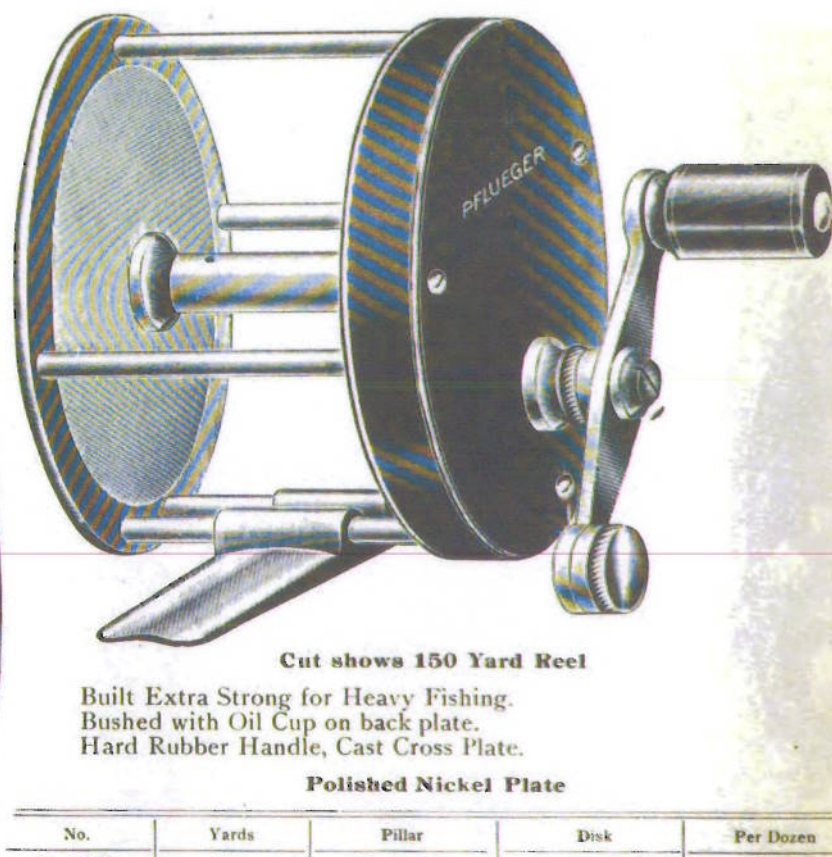

Cut shows 150 Yard Reel

Built Extra Strong for Heavy Fishing.
Bushed with Oil Cup on back plate.
Hard Rubber Handle, Cast Cross Plate.

Polished Nickel Plate

No.	Yards	Pillar	Disk	Per Dozen
No. 356R	150	1 $\frac{7}{8}$ in. long	3 in. diam.	\$27 36
" 357R	200	1 $\frac{7}{8}$ "	3 $\frac{1}{4}$ "	29 47
" 358R	250	1 $\frac{7}{8}$ "	3 $\frac{1}{2}$ "	31 57
" 359R	300	1 $\frac{7}{8}$ "	3 $\frac{3}{4}$ "	33 68

Packed—One in a box.

Please Order Our Goods Through Your Jobber

Pflueger's Salt Water Reel

Extra Fine Rubber, Multiplying, Back Sliding Click

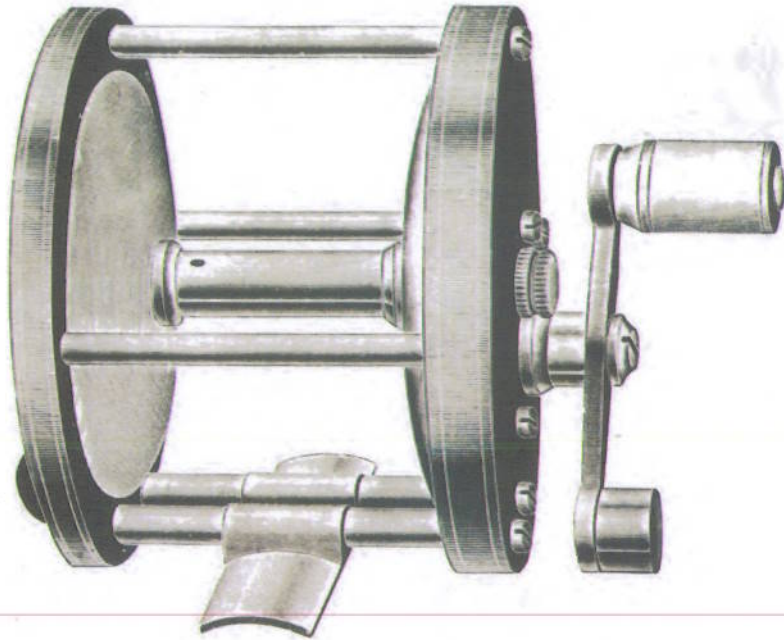

Engraving shows 150 yard Reel

Steel Pivots and Cog Post, Bushings with Oil Cups on Front and Back Plate. Bridged Front Plate, Cast Cross Plate, White Handle.

Extra Quality Rubber—Nickel Plated.

Nickel Plated	Yards	Filler	Disk	Per Dozen
No. 366	150	1 7/8 in. long	3 in. diam	\$37 89
" 367	200	1 7/8 in. long	3 1/4 in. diam	44 20
" 368	250	1 7/8 in. long	3 1/2 in. diam	50 52
" 369	300	1 7/8 in. long	3 3/4 in. diam	56 84

Packed—One in a box.

Pflueger's Salmon Reel

Fine Quality, Metal Bound, Single Action with Back Sliding Click

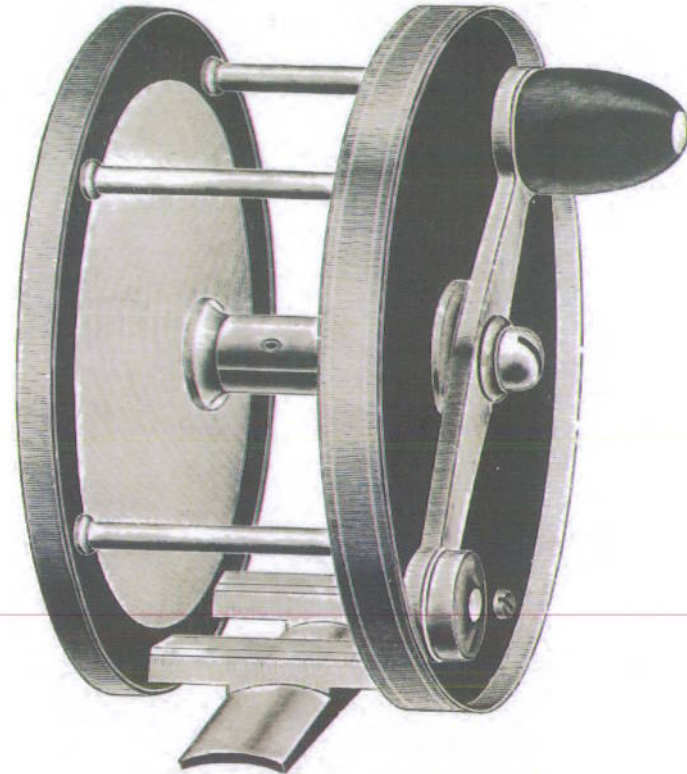

Engraving shows 200 yard Reel

Steel Pivots, Steel Spring, Tongue and Ratchet tempered Blue. Cast Cross Plate, Hard Rubber Handle, Bushed with Oil Cup on Back Plate.

Made in Polished Nickel Plate or German Silver

Polished Nickel Plate	Each	German Silver	Each	Yards	Fillars	Disk
No. 398	\$ 6 31	No. 698	\$10 00	250	1 1/2 inch	3 1/2 inch
" 399 1/2	8 42	" 699 1/2	12 10	350	1 1/2 inch	4 inch
" 400	12 63	" 700	18 31	450	1 1/2 inch	4 1/2 inch

Packed—One in a box.

Please Order Our Goods Through Your Jobber

Pflueger's Salmon Reel

Single Action, Hard Rubber, Metal Bound, Stationary Steel
Click on Back, Bushed, with Oil Cup on Back Plate

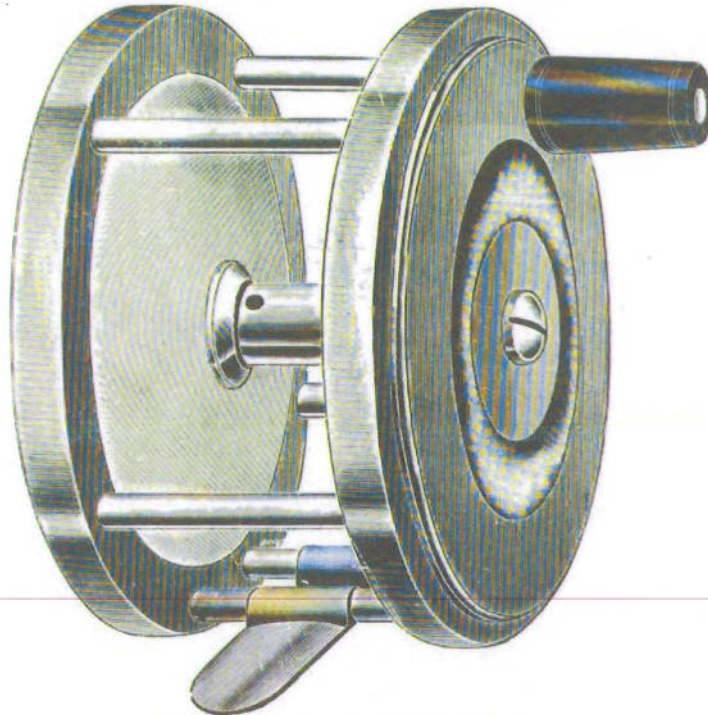

Engraving shows 250 Yard Reel

This is strictly a High Grade Reel in every respect.

Oxidized Brass.

No.	Yards	Pillar	Disk	Price Each
388	250	1 1/2 inch	3 1/2 inch	\$ 7 89
389 1/2	350	1 3/8 "	4 "	10 00
390	450	1 1/2 "	4 1/2 "	14 20

Packed—One in a box.

Pflueger's Tarpon Reel

Round Rubber, Metal Bound, Multiplying, Adjustable
Back Sliding Click

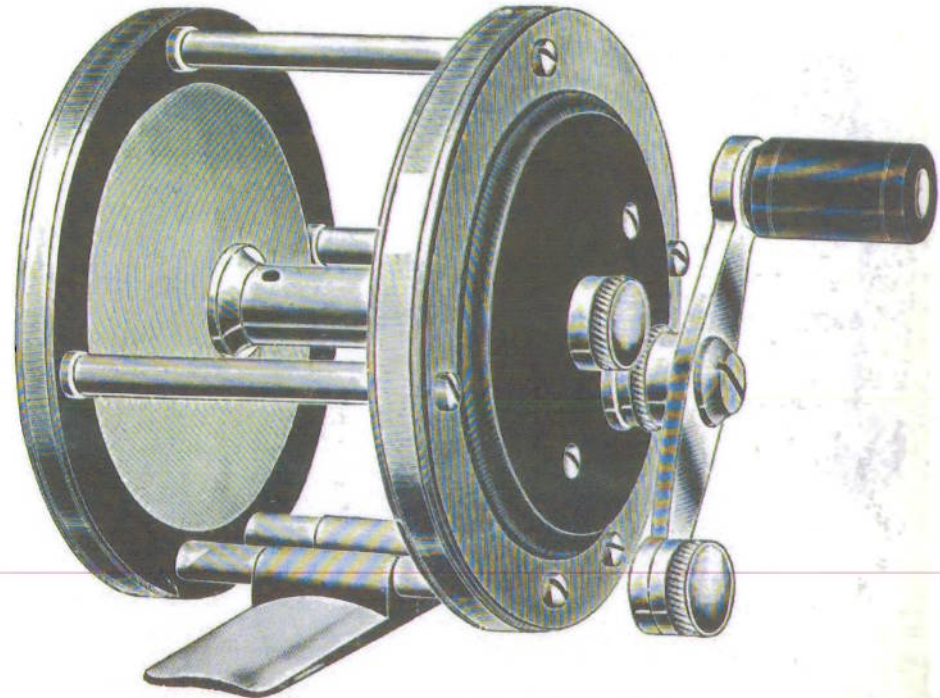

Engraving shows 250 Yard Reel

Hard Rubber Handle. Cast Cross Plate. Steel Pivots and Cog Post. Bushings with Oil Cups on Front and Back Plate. Bridged Front Plate.

Polished Nickel Plate	Price Each	German Silver	Price Each	Yards	Pillar	Disk
No. 406	\$ 5 89	No. 416	\$ 8 00	150	1 3/8 inch	3 inch
" 407	7 37	" 417	9 47	200	1 7/8 "	3 1/4 "
" 408	8 42	" 418	10 53	250	2 "	3 1/2 "
" 409	9 47	" 419	11 58	300	2 "	3 3/4 "
" 409 1/2	11 58	" 419 1/2	13 68	350	2 1/8 "	4 "
" 409 3/4	12 63	" 419 3/4	14 73	400	2 1/4 "	4 1/4 "
" 410	14 20	" 420	16 31	450	2 3/8 "	4 1/2 "

Packed—One in a box.

Please Order Our Goods Through Your Jobber

Pflueger's Fine Quality, Hard Rubber, Round, Salt Water Reel

With Aluminum Metal Interleaved, Multiplying, with Adjustable Back Sliding Click
Patented

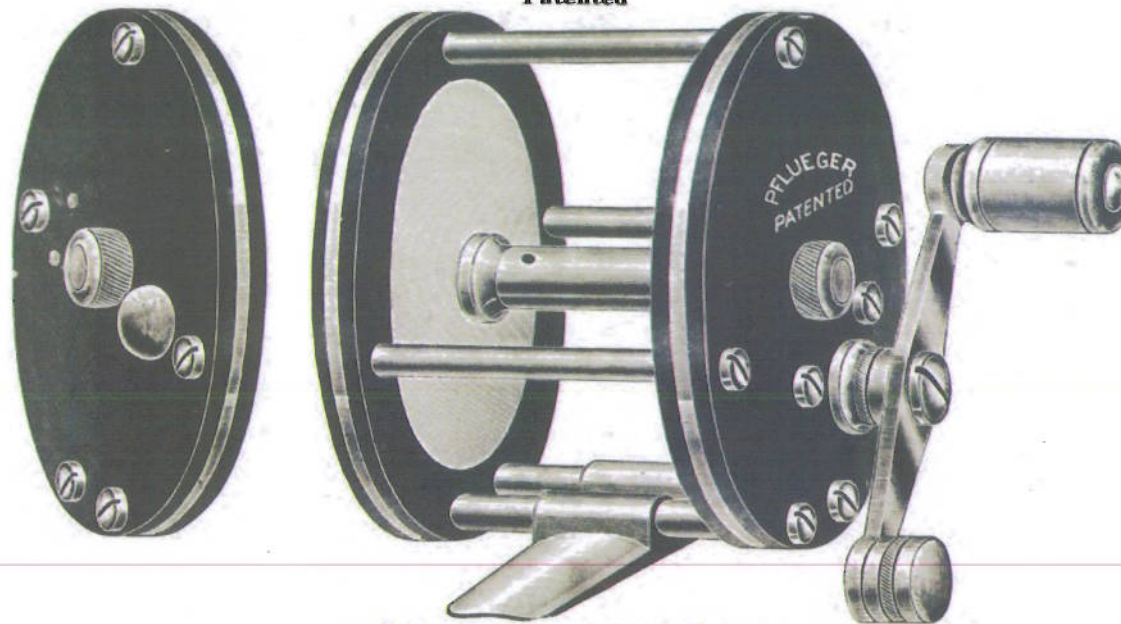

Cut shows actual size, 150 yard

We mention a few of the many advantages this patented reel has over the old construction.

The aluminum metal interleaved with the hard rubber on the side plates adds greatly to the strength of the reel, prevents splitting and warping of the rubber, reduces the weight of reel and greatly beautifies it.

Bushings, collars, crossplate and other attachments are fastened direct to the aluminum plate thereby relieving the possibility of coming loose or breaking out.

Reel is constructed with Phosphor bronze bearings. Stubb's steel pivots. German Silver spool. Pillars, Crossplate and Crank. Hard rubber handle.

No.	Yards.	Pillar.	Disk.	Each.
726	150	1 $\frac{7}{8}$ in. long	3 in. dia.	\$7 36
727	200	1 $\frac{7}{8}$ " "	3 $\frac{1}{4}$ " "	9 45
728	250	1 $\frac{7}{8}$ " "	3 $\frac{1}{2}$ " "	11 58
729	300	1 $\frac{7}{8}$ " "	3 $\frac{3}{4}$ " "	13 68
729 $\frac{1}{2}$	350	1 $\frac{7}{8}$ " "	4 " "	15 78

Packed—One reel in a heavy fancy card box.

Please Order Our Goods Through Your Jobber

PFLUEGER'S HARD RUBBER TUNA REEL, MULTIPLYING WITH ADJUSTABLE BACK SLIDING CLICK

Capacity 300 Yards No. 24 Cuttyhunk Line

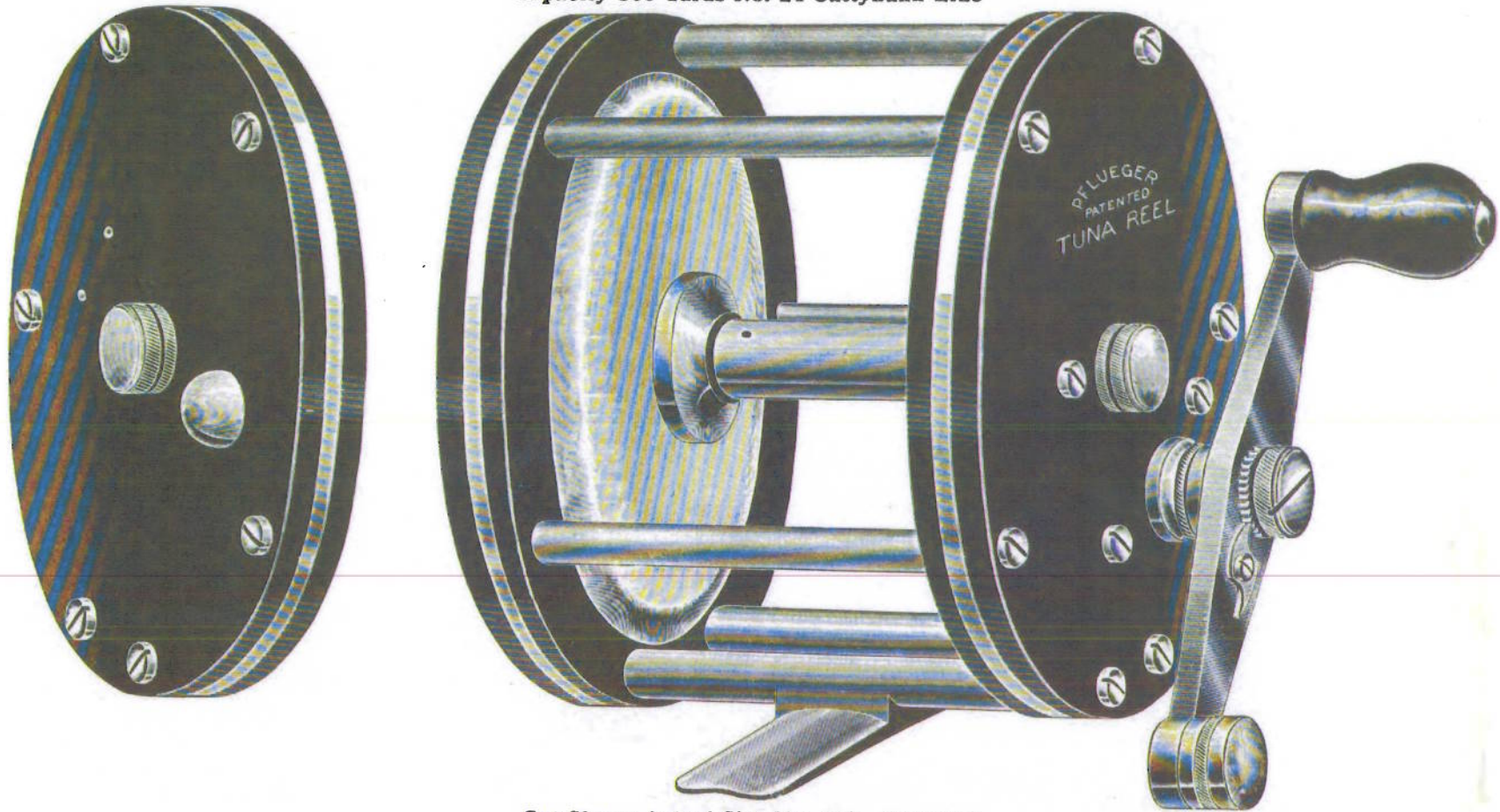

Cut Shows Actual Size No. 710. Patented

This reel is especially designed to meet the demand for a powerful reel and the terrific strain of a Tuna rush. The side plates are made of extra fine quality hard rubber interleaved with a sheet of aluminum metal which is exposed on the edge of the plate, and the beautiful polished white aluminum in contrast with the polished black rubber produces a most pleasing effect, and not alone this, but the aluminum also prevents the warping or splitting of the rubber, reduces the weight of the reel and many other advantages of minor importance. The bushings, collars, cross plate and other attachments are fastened direct to the aluminum metal plate, thereby getting the full strength of the metal, which is many times stronger than the old way of fastening to the hard rubber. This reel has the following construction: Phosphor Bronze Bearings, Stubb's Steel Pivots, German Silver Spool, Crossplate, Pillars and Crank. The crank has a ratchet lock which prevents the same coming loose. We fully guarantee this reel.

No. 710. Capacity 300 yards, No. 24 Cuttyhunk Line. Price each, \$33.68.

Packed—One reel in a chamos lined leather case, one case in an extra strong card box.

Please Order Our Goods Through Your Jobber

Pflueger's Wood Reel and Line Dryer

Enameled No. 337

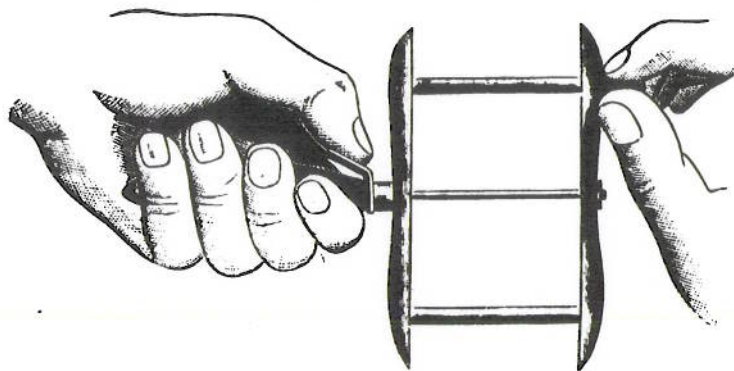

Cut Shows 1/2 Size No. 1

CAN BE USED AS A REEL AND LINE DRYER

Made of well seasoned hard wood, and firmly put together. Furnished with a Lever Brake to be operated with the thumb, as shown per above cut.

Heavily enameled in assorted colors—Black, Green and Red. A very handsome and cheap Reel.

	Sizes....	1	2	3
No. 337.....	Per gross	\$10 55	\$12 65	\$14 75

Packed—One in a box.

Pflueger's Fishing Reel Oil Cups



No. 163



No. 473. Without Jewel



No. 463. With Jewel

	Per Dozen		Per Dozen		Per Dozen
Brass.....	\$0 64	Nickel on Brass.....	\$1 06	Nickel on Brass.....	\$7 38
Nickel on Brass.....	94	German Silver.....	1 26	German Silver.....	7 58
German Silver.....	1 16				



No. 406



No. 366

	Per Dozen		Per Dozen
Nickel on Brass.....	\$1 06	Nickel on Brass.....	\$1 06
German Silver.....	1 26	German Silver.....	1 26

Please Order Our Goods Through Your Jobber

PFLUEGER'S FISHING REEL GEARS AND PINIONS

DOUBLE MULTIPLYING GEARS AND BRASS PINIONS

No. R162



No. R162

Brass Gear.....Price Each 15 cents
 " Pinion....." " 10 cents
 Will fit our 40 Yard Round or Raised Reels

No. R163



No. R163

Brass Gear.....Price Each 20 cents
 " Pinion....." " 10 cents
 Will fit our 60 Yard Round or Raised Reels

No. R164

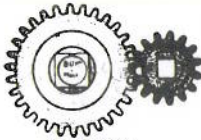

No. R164

Brass Gear.....Price Each 20 cents
 " Pinion....." " 10 cents
 Will fit our 80 Yard Round or Raised Reels

No. R165

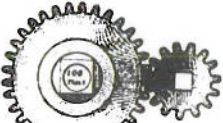

No. R165

Brass Gear.....Price Each 26 cents
 " Pinion....." " 16 cents
 Will fit our 100 Yard Round or Raised Reels

No. R166

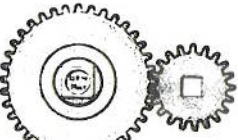

No. R166

Brass Gear.....Price Each 26 cents
 " Pinion....." " 16 cents
 Will fit our 150 Yard Fresh Water Reels

The above Engravings show exact sizes

DOUBLE MULTIPLYING GEARS AND PINIONS FOR SALT WATER REELS

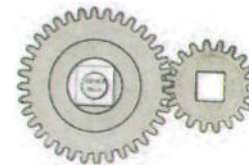

No. R406

Brass Gear.....Price Each 26 cents
 " Pinion....." " 16 cents
 Will fit our 150 or 200 Yard Salt Water Reels

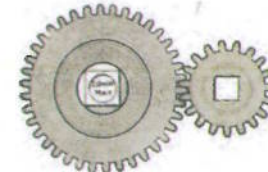

No. R408

Brass Gear.....Price Each 30 cents
 " Pinion....." " 20 cents
 Will fit our 250 or 300 Yard Salt Water Reels

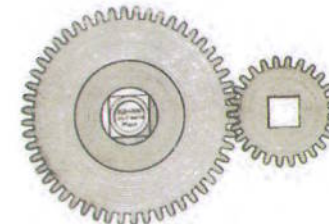

No. R410

Brass Gears.....Price Each 36 cents
 " Pinion....." " 26 cents
 Will fit our 350 or 400 Yard Salt Water Reels

The above Engravings show exact sizes

Please Order Our Goods Through Your Jobber

Pflueger's Quadruple Reel, Gears and Pinions

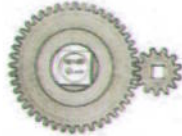

No. R 192

Brass Gear..... Price each 36c
Steel Pinion..... " 26

Will fit over 40 yard Round or 60 yard Raised Pillar Reels.

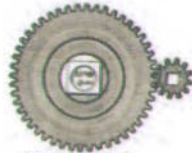

No. R 193

Brass Gear..... Price each 36c
Steel Pinion..... " 26

Will fit our 60 yard Round or 80 yard Raised Pillar Reels.

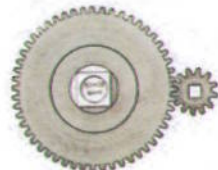

No. R 194

Brass Gear..... Price each 40c
Steel Pinion..... " 26

Will fit our 80 yard Round or 100 yard Raised Pillar Reels

The above engravings show exact size.

Pflueger's Reel Screws



1
1/4 Inch 4-36

Brass..... Per dozen 24c
Nickel on brass " 40
German silver " 50



2
1/4 Inch 4-36

Brass..... Per dozen 18c
Nickel on brass " 34
German silver " 44



3
1/4 Inch 4-36

Brass..... Per dozen 18c
Nickel on brass " 34
German silver " 44



4
1/4 Inch 3-48

Brass..... Per dozen 18c
Nickel on brass " 34
German silver " 44



5
1/4 Inch 3-48

Brass..... Per dozen 18c
Nickel on brass " 34
German silver " 44



6
1/4 Inch 3-48

Brass..... Per dozen 18c
Nickel on brass " 34
German silver " 44



7
1/4 Inch 3-48

Brass..... Per dozen 18c
Nickel on brass " 34
German silver " 44



8
1/4 Inch 4-36

Brass..... Per dozen 24c
Nickel on brass " 40
German silver " 50



9
1/4 Inch 3-48

Brass..... Per dozen 18c
Nickel on brass " 34
German silver " 44



100
1/4 Inch 4-36

Brass..... Per dozen 24c
Nickel on brass " 40
German silver " 50



101
1/4 Inch 3-48

German silver Per dozen 50c



8
1/4 Inch 8-32

Brass..... Per dozen 24c
Nickel on brass " 40
German silver " 50



21
1/4 Inch Head

Brass..... Per dozen 30c
Nickel on brass " 46
German silver " 56



22
1/4 Inch Head

Brass..... Per dozen 36c
Nickel on brass " 52
German silver " 60



23
1/4 Inch Head

Brass..... Per dozen 40c
Nickel on brass " 56
German silver " 66

The above engravings show exact size.

Please Order Our Goods Through Your Jobber

PFLUEGER'S SINGLE ACTION REEL HANDLES

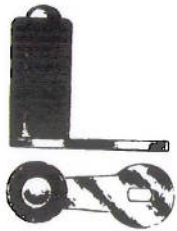

No. R11

25 Yard Handle

Brass, Black	Wood Handle.....	Each	6c
"	Composition Handle	"	10c
Nickel, "	Wood	"	10c
"	Composition	"	14c

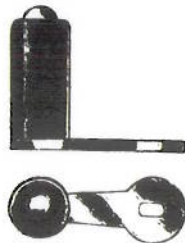

No. R12

40 Yard Handle

Brass, Black	Wood Handle.....	Each	6c
"	Composition Handle	"	10c
Nickel, "	Wood	"	10c
"	Composition	"	14c

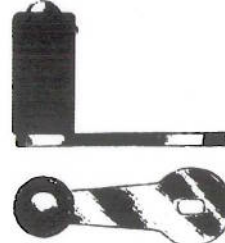

No. R13

60 or 80 Yard Handle

Brass, Black	Wood Handle.....	Each	8c
"	Composition Handle	"	10c
Nickel, "	Wood	"	10c
"	Composition	"	14c

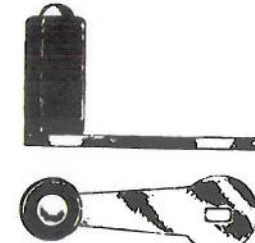

No. R15

100 Yard Handle

Brass, Black	Wood Handle.....	Each	10c
"	Composition Handle	"	14c
Nickel, "	Wood	"	14c
"	Composition	"	18c

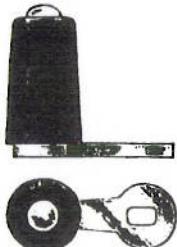

No. R72

40 Yard Handle

Brass, Black	Composition Handle, Each	10c
Nickel, "	"	14c

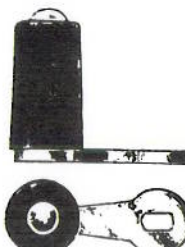

No. R73

60 Yard Handle

Brass, Black	Composition Handle, Each	10c
Nickel, "	"	14c

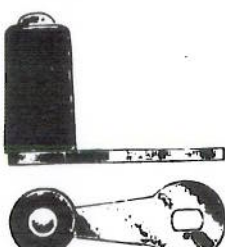

No. R74

80 Yard Handle

Brass, Black	Composition Handle, Each	10c
Nickel, "	"	14c

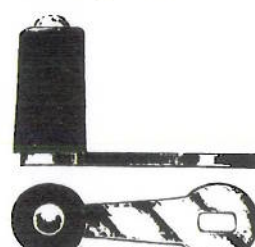

No. R75

100 Yard Handle

Brass, Black	Composition Handle, Each	14c
Nickel, "	"	18c

PFLUEGER'S BALANCED REEL HANDLES

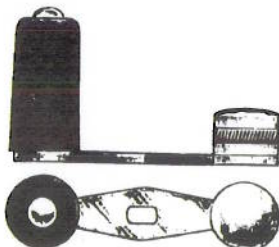

No. R152

40 Yard Handle

Brass, Black	Composition Handle, Each	14c
Nickel, "	"	20c
" White	"	26c

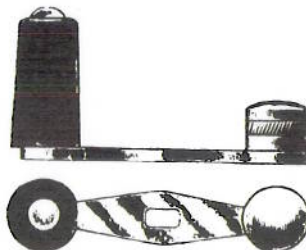

No. R153

60 Yard Handle

Brass, Black	Composition Handle, Each	14c
Nickel, "	"	20c
" White	"	26c

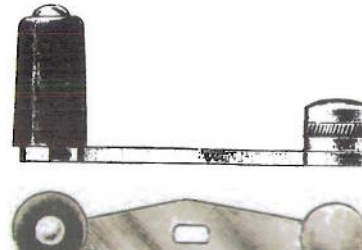

No. R154

80 Yard Handle

Brass, Black	Composition Handle, Each	14c
Nickel, "	"	20c
" White	"	26c

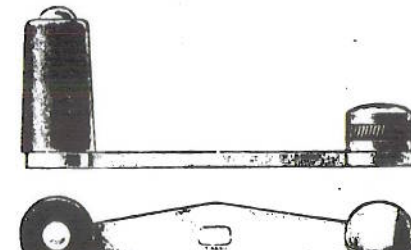

No. R155

100 Yard Handle

Brass, Black	Composition Handle, Each	20c
Nickel, "	"	26c
" White	"	30c

The above engravings show exact sizes
Please Order Our Goods Through Your Jobber

PFLUEGER'S BALANCED REEL HANDLES

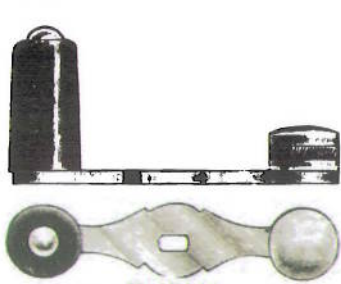

No. R112

40 Yard Handle

Brass, Black Composition Handle, Each 20c
 Nickel, " " " 26c
 " White " " " 26c

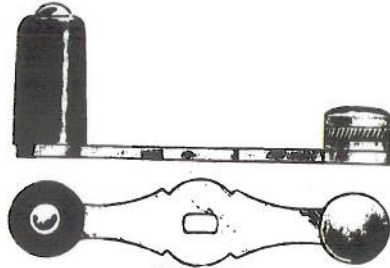

No. R113

60 Yard Handle

Brass, Black Composition Handle, Each 20c
 Nickel, " " " 26c
 " White " " " 26c

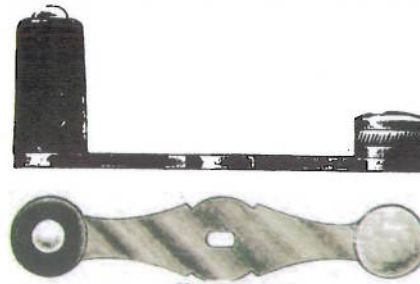

No. R114

80 Yard Handle

Brass, Black Composition Handle, Each 26c
 Nickel, " " " 30c
 " White " " " 30c

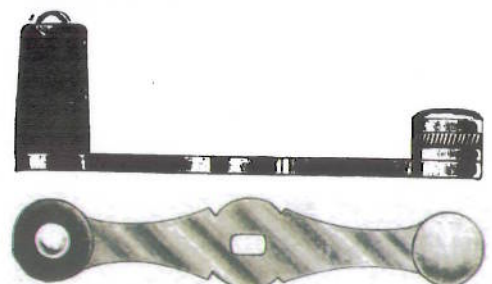

No. R115

100 Yard Handle

Brass, Black Composition Handle..... Each 26c
 Nickel, " " " 30c
 " White " " " 30c

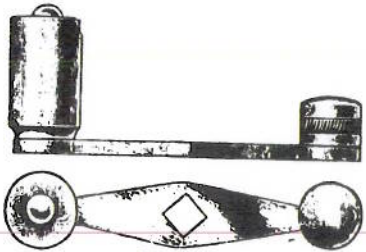

No. R242

40 and 60 Yard Handle

Nickel Hard Rubber Handle.. Each 26c
 " White Ivory " " 30c

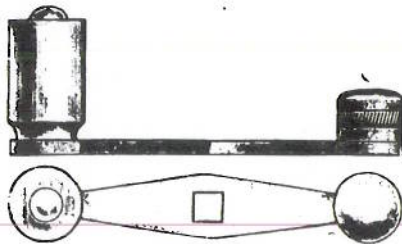

No. R243

60 and 80 Yard Handle

Nickel Hard Rubber Handle. Each 26c
 " White Ivory " " 30c

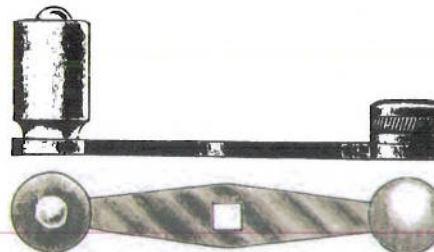

No. R244

80 and 100 Yard Handle

Nickel Hard Rubber Handle..... Each 30c
 " White Ivory " " 36c

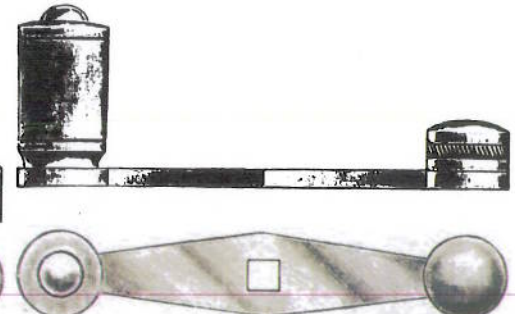

No. R486

150 Yard Handle

Nickel Hard Rubber Handle Each 30c
 " White Ivory " " 36c

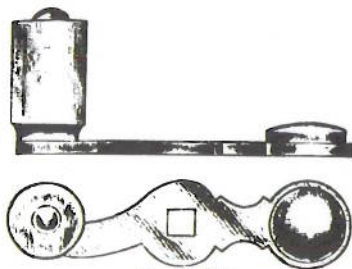

No. R192

40 and 60 yards Handle

Nickel, White Ivory Handle..... Each 40c
 German Silver, White Ivory Handle..... " 50c

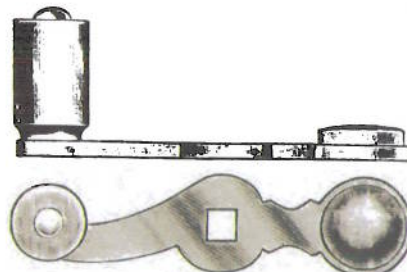

No. R193

60 and 80 Yard Handle

Nickel, White Ivory Handle..... Each 40c
 German Silver, White Ivory Handle..... " 50c

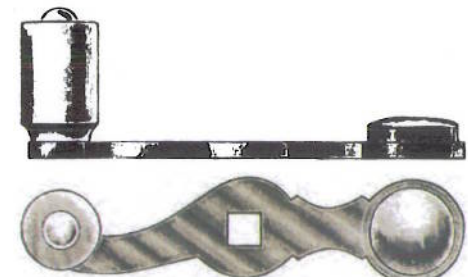

No. R194

80 and 100 Yard Handle

Nickel, White Ivory Handle..... Each 46c
 German Silver, White Ivory Handle..... " 56c

Please Order Our Goods Through Your Jobber

PFLUEGER'S SALT WATER REEL HANDLES

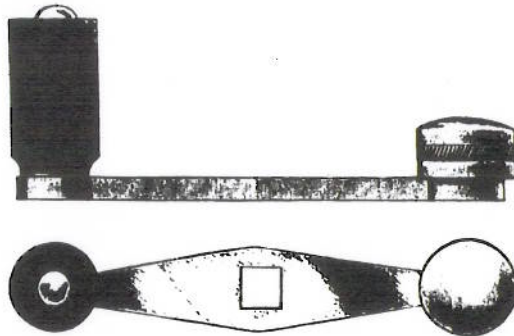

No. R346
150 and 200 Yard Handle

- Nickel, Hard Rubber Handle..... Each 50 cents
- " White Handle " 56 cents
- German Silver, White Handle..... " 70 cents

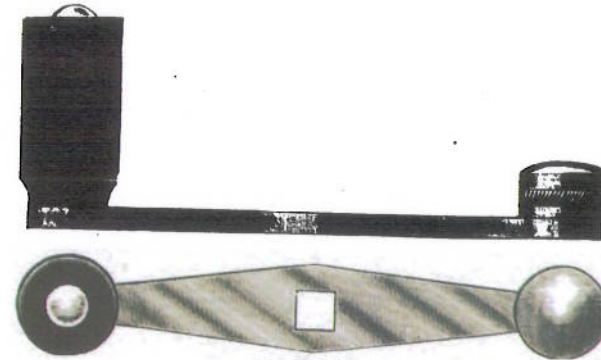

No. R348
250 and 300 Yard Handle

- Nickel, Hard Rubber Handle Each 56 cents
- " White Handle " 60 cents
- German Silver, White Handle " 78 cents

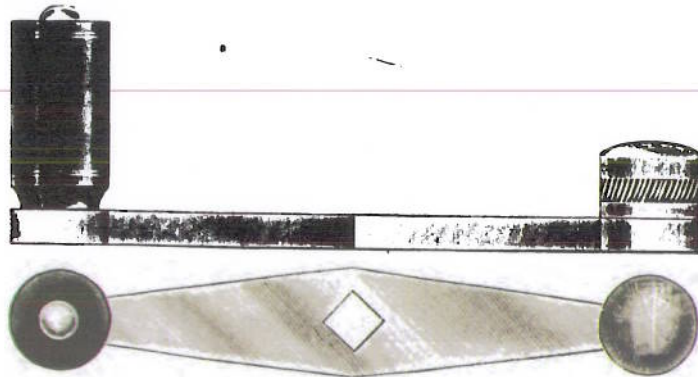

No. R420
350 and 400 Yard Handle

- Nickel, Hard Rubber Handle Each 60 cents
- " White Handle..... " 86 cents
- German Silver, White Handle..... " 80 cents

PFLUEGER'S AKRON AND KENTUCKY REEL HANDLES

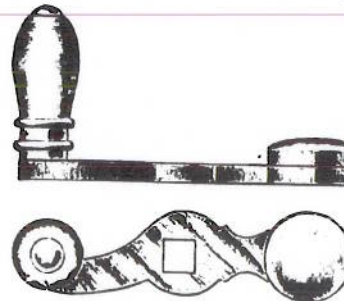

No. R422 and R423
40 and 60 Yard Handle
German Silver, Genuine Ivory
Handle..... Each 80 cents

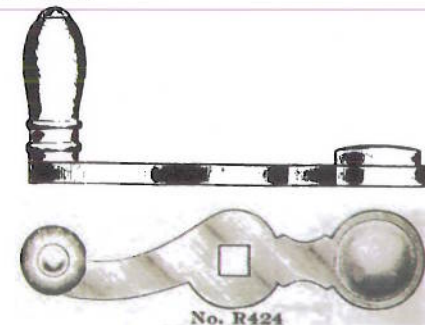

No. R424
80 and 100 Yard Handle
German Silver, Genuine Ivory
Handle..... Each 90 cents

Engravings on this page show exact size
Please Order Our Goods Through Your Jobber

INDEX TO STOCK NAMES

Page.	Page.	Page.	Page.				
Aberdeen Snells	28	Daisy Spinner	100	Kidney Baits	67	Reels, Wood	147
American Phantom Minnows	50	Dipsea Lines	119	Kidney Ball Baits	71	Reels, Metal	131-146
Admiral Bait	53	Disgorgers	111	Kidney Beaded Baits	73	Sproat Snells	25
Angle Worms	57	Diamond Connecting Links	110	Limerick Snells	23	Sneck Snells	26
American Spinners	79	Ebony Leaders	35	Leaders, Gut	34-35	Silk Worm, Gut	36
Argus Spoon	80	Egg Ball Baits	72	Luminous Flies	44-45	Snelled Hooks	22-33
Adirondack Spinner	100	Everlasting Snells	33	Lady Bird	59	Screws, Reel	149
Anglers' Wax	111	Egg Beaded Baits	74	Lake Tahoe Spoons	95	Spinning Coachman	41
Assortments Spoon and Rubber Baits	96	Emeric Spinner	103	Line Spreaders	108	Six Winged Wonders	43
Blackfish Snells	33	Flies, Artificial	36 to 45	Limerick Hooks, Ringed and Flatted	4-5	St. Lawrence Minnow Gangs	47
Blackfish Hooks	12	Famed Phantom Minnows	51	Mackerel Hooks, Drop Point	12	Soft Rubber Minnows	52
Beetle	59	Fish Spearing Decoy Minnows	56	Minnesota Bass Snells	27	Shrimp	57
Bass Killers	41	Frogs	57-60	Minnow Gangs, Imperial	46	Spider	59
Black Fly	59	Fern Fly	59	Minnow Gangs, St. Lawrence	47	Soft Rubber Baits	57-60
Black Bass Baits	76-85	Floating Meadow Frog	60	Minnows, Phantom	49-51	Success Spoons	66
Bolt Spoon	85	Fluted Spoons	65	Minnows, Hard and Soft Rubber	52	Star Baits	77
Bucktail Specialties	88-89	Fish Clamp	109	Minnows, Devon	54	Salmon Trolling Rig	89
Bucktail Flies	39	Fish Scalars	109	Minnow Troty	55	Special Salmon Spoon	91
Bass Spinners	101	Frog Rig	103	May Fly Ass't	40	Salmon Trollars	91
Brass Box Swivels	107	Fish and Frog Spears	110	Muskallonge Minnow	56	Skittering Baits	93
Brass Barrel Swivels	107	Ferrule and Rod Cement	111	Minnows, Decoy	56	Spoon Assortment Cards	96
Carlisle Hooks, Ringed and Flatted	8	Fish Hook Extractors	111	May Fly, Soft Rubber	58	Spinners	99-103
Carlisle Snells	24	Fly Cream	111	Montreal Bait	70	Set Lines	124
Cincinnati Bass Snells	27	Fish Stringers	112	Muskallonge Spoons	82	Sidney Spinners	99
Cincinnati Bass Hooks, Ringed and Flatted	9	Fish Fork	113	May Bug Spinner	86	Swivels	107
Cholmondeley Pennell Turndown Eyed Hook Snells	30-33	Feathered Treble Hooks	117	McMurray Spinner	87	Slack Line Attachment	109
Chestertown Snells	30	Furnished Lines	119-123	Mumford's Bait Box	108	Sinker, Happy Thought	107
Catch the Nibbler Snells	31	Furnished Set Lines	124	Metal Reels	131-146	Spears, Fish and Frog	110
Cable Leaders	35	Floats	125-130	New York Trout or Bass Snells	29	Set Line Snaps	110
Casting Minnows	52	Gut Leaders	34-35	New Akron Spinner	62	Set Line Snaps and Rings	110
Crawfish	57	Gut Silk Worm	36	Nickel Plated Baits	67	Stringers	112
Cricket	58	Governor Bait	53	New Pike Spoon	92	Sinkers	114-116
Chugging Rig	113	Grasshoppers	57-58	Oil Cups for Fishing Reels	147	Screws for Reels	149
Cyclone Spinners	63-64	Gaff Hooks	113	O'Shaughnessy Snells	30	Salt Water Snells	33
Clipper Spoons	66	Gears and Pinions for Reels	148-149	Ohio Spoons	69	Tarpon Hooks	33
Coburg Baits	75	Handles for Reels	150-152	Oval Hammered Baits	69	Troy Minnow	55
Crescent Baits	78	Hooks, Ringed and Flatted	4 to 21	Oval Plain Baits	69	Tandem Spinners	61
Columbia Spoon	80	Halibut Hooks	21	Original Emeric Spinners	103	Trolling Rig, Salmon	89
Cayuga Lake Spoons	83	Hercules Fish Stringers	112	Olympia Spinners	106	Truckee Bait	95
Captain Spoon	85	Hooks on Wire	48	Pennell Hook Snells	30-33	Tahoe Spoons	95
Combination Changeable and Reversible Spoons in sets	86	Hard Rubber Minnows	52	Pacific Coast Snells	32	Tacoma Trout Baits	97-99
Commodore Spoon	92	House Fly	59	Prize Winners	42	Trout Spinner	101
Catskill Spinner	100	Heart Shape Baits	80	Phantom Minnows	49-51	Trolley Rig	112
Casting Spinners	102	Holt's Muskallonge Spoons	90	Pearl Phantom Minnow	40	Trolling Outfits	119
Climax Bass Baits	104	Happy Thought Sinker	107	Pike Baits	68	Universal Tackle Assortment	124
Cross Line Swivels	107	Hook Extractors or Disgorgers	111	Porpoise Hide Phantoms	49	Virginia Hooks, Taper Point	10
Clearing Ring	104	Handy Line Winder	113	Paragon Spoons	69	Worms, Angle	57
Connecting Links	110	Hooks, Treble	117	Peerless Spoon	80	Wasp	58
Cod Hooks, Ringed and Flatted, I. P.	16-17	Indiana Bass Snells	27	Perfect Revolving Heart Baits	81	Windsor Spoon	80
Central Draught Hooks, Ringed, Eyed and Flatted	18-20	Indiana Spinners	62	Pearl Spoons	84	Wilson Bait	94
Cork Floats	125-128	Indestructible Snells	32	Puget Sound Bait	92	Western Bait	94
Devon Minnows	54	Imperial Minnow Gangs	46	Pet Spinner	100	Wire Leader	110
Dobsons	57	Insects, Soft Rubber	58-59	Pearl Emeric Spinner	103	Weed Protectors	118
Decoy Minnows	56	Imperial Spoons	91	Phantom Spinners	105	Wooden Minnows	55
Dominion Spoons	69	Kirby Snells	23	Pearl Squids	105	Wood Floats	129-130
Delavan Bait	86	Kirby Hooks, Ringed and Flatted	6-7	Practice Casting Frogs	60	Wood Reels	147
Double Egg Spinner	87	Kirby Sea Hooks	14-15	Quill Floats	129	Wizard Minnow	55
		Kirby Bass or Salmon Hooks	13	Quill Top Floats	127-128-130	Weedless Treb. Hooks	118
		Kinsey Trout Hooks	11	Rubber Bait Assortment Cards	58-59	Weedless Hook, Perfection	118
		Kinsey Snells	30	Roanoke Spinner	102	Weedless Hook, Expert	118

INDEX TO STOCK NUMBERS

Nos.	Page.	Nos.	Page.	Nos.	Page.	Nos.	Page.
25-26	42	282	35	709-714	57	1358-1365	98
27-32	43	283	111	715	52	1366-1373	97
35-38	62	301-308	77	721	113	1374-1376	75
40-44	87	321-323	86	722	96	1377-1380	101
45-46	90	325-333	78	723	109	1384-1385	112
47-58	79	337	147	725-726	96	1390-1391	117
65-6	129	340-341	112	728	109	1409-1415	51
74-81	62	346-348	64	730	72	1493	108
85-86	129	350-351	118	731	72-96	1494-1499	118
95-98	62	365-370	104	734	96	1511-1517	51
101-102	41	374	100	735	59	1520-1521	40
105-106	45	375	101	739	104	1534-1536	101
107	45-65	376-378	100	750-754	59	1580-1585	54
108-110	65	380-382	85	755-758	53	1590-1597	98
112-115	68	385-386	41	759-764	57	1600-1617	99
116	76	387	41-86	765	52	1625-1648	130
117-123	48	388-392	86	766-767	57	1651-1652	129
125-126	102	400-407	93	768-769	96	1745	40
127-128	101	408-409	92	770-771	58	1890	112
132-134	66	410	109	772-773	57	1998-1999	61
137-138	113	411	93	774-775	60	2000-2001	61-130
139	65	415-421	37	776-777	103	2002-2012	61
140	110	425-435	107	780	60		
143	66	436-438	106	791	114		
144-159	92	450-451	88	792	53		
160-161	81	452-455	89	793	114		
162	58	456-460	88	795-797	115		
163	59	461-462	89	800-801	114		
169	105	463-475	55	802-803	116		
175	58	514	107	805	112		
176	59	540-541	39	806	103		
177-179	76	542-543	42	807	108		
180	100	548-554	103	808-815	91		
183-184	39	560-561	101	816	103		
187-188	117	562-565	102	817	110		
189-190	84	580-588	95	818-819	56		
191	74	604	108	821	111		
193	73	605-606	110	830-838	95		
195-196	74	607	69	870-878	89		
197-198	56-73	614-615	71	890-918	94		
199-200	56	617	69	925	105		
201	100	619-621	67	930-943	94		
204-209	100	622	110	975-976	86		
210-213	125	625	68	985-986	62		
214-217	126	630	72	995	53		
218-225	91	631	70	1000	124		
226	52	632	69	1001	85-124		
227	57	633	70	1005-1016	50		
228	69	635	69	1017-1018	49		
229	71	636	70	1019-1022	105		
231-232	39	642-643	85	1025-1030	127		
237-244	91	644-653	83	1040-1051	128		
245-252	97	655-656	80	1285	111		
253-260	103	660-661	80	1288-1290	113		
264	52	670-679	82	1300-1311	49		
265	57	690-692	87	1330-1341	52		
272	35	700-704	59	1342-1349	98		
279	81	705-708	53	1350-1357	97		

FISHING REELS.

I-55	131
62-85	131
112-145	132
152-176	133
182-186	133
192-195	135
203-206	134
212-215	136
242-245	134
262-266	136
273-285	137
293-295	137
302-305	137
323-336	133
346-349	141
346R-349R	141
356-359	142
356R-359R	142
366-369	143
388-390	144
398-400	143
406-420	144
422-445	140
462-475	139
482-496	136
503-515	134
523-526	138
532-535	132
542-555	135
562-566	133
592-595	135
710	146
726-729½	145



THE ENTERPRISE MFG. CO.
AKRON, OHIO, U.S.A.
EXCLUSIVELY MANUFACTURERS