

# The Fishing Tackle

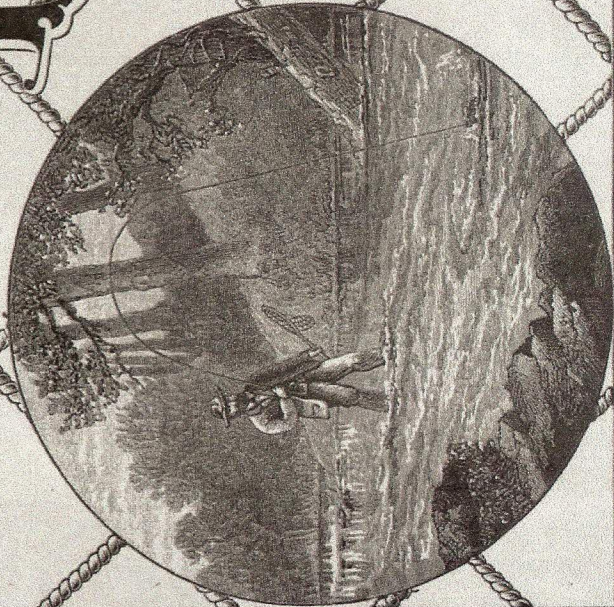

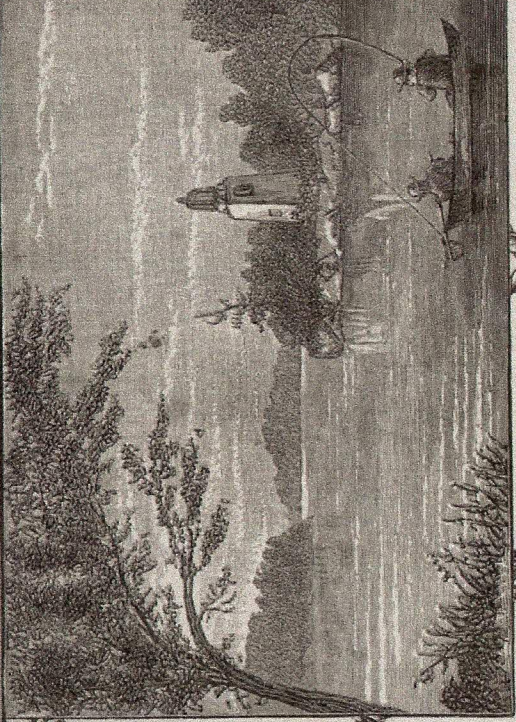

# ILLUSTRATED CATALOGUE

AND

PRICE LIST

OF

# FINE FISHING TACKLE

MANUFACTURED BY

ABBIEY & IMBRIE,

OFFICE, NO. 48 MAIDEN LANE,

NEW YORK, U.S.A.

---

PRICE, FIFTY CENTS.

---

COPYRIGHT 1884

By CHAS. F. IMBRIE.

**Rod Rings and Keepers.**

**Plate 45.**

	PER DOZ.
Best White Rod Rings, any size.....	.05
“ “ Keepers “ .....	.04

	PER GROSS.
“ “ Rod Rings and Keepers in packages, assorted sizes; 1 gross of each, Rings and Keepers.....	.60

Extra Quality German Silver Rings .....	PER DOZ.	.10
-----------------------------------------	----------	-----

**Guides, (all Hard Solder).**

	PER DOZ.
Brass, 3/0 2/0 1/0.....	.50
“ 1 @ 5.....	.40

German Silver, 3/0 2/0 1/0 (Drilled).....	2 50
-------------------------------------------	------

“ “ 1 @ 5.....	1 00
----------------	------

“ “ arched anti friction, 3/0 2/0 1/0.....	3 00
--------------------------------------------	------

“ “ “ “ “ 1 @ 5 .....	1 50
-----------------------	------

Brass standing, all sizes.....	45
--------------------------------	----

German Silver, standing, all sizes.....	1 00
-----------------------------------------	------

Any of above Nickel Plated, per dozen extra, .15

**Tips.**

Nos.	1 2	3 4	5 @ 8	9 @ 12
Brass Tube Sgl., 1 00	.75	.70	.65 per doz.	
“ “ Dbl., 1 40	1 25	1 15	1 00	“

Nickel Plated, per dozen, .25 extra.

Nos.	1 2	3 4	5 6	7 8	9 10	11 12
Ger. Silver Sgl., Per Doz.,	2 00	1 80	1 65	1 50	1 40	1 25

do. Double	2 50	2 30	2 20	2 00	1 80	1 70
------------	------	------	------	------	------	------

**Fly Ring Tips.**

	PER DOZ.
Brass, Single Ring.....	.45
German Silver, Single Ring.....	.65

“ “ Treble Ring, Trout Size.....	1 50
----------------------------------	------

“ “ “ “ Salmon “ .....	2 00
------------------------	------

**REELS.**

The prices of any of the following Reels, which are designated “with click,” with “drag,” or “Nickel plated,” include those additions.

We will put click, or drag in, or nickel plate any Reel, not designated as having these additions, at 50c. per Reel extra, for each or any addition.

All reels (excepting Nos. 11 to 27) are made with best quality screws, so that they can be taken apart if necessary.

All our reels are hand-made, the Metal is all “Cold-Rolled,” not Common “Sheet;” the rubber is best quality and polished.

**Dip Finish, Brass, Not Multiplying.**

**WITHOUT CLICK.**

**Plate 46.**

Price Each,	.50	.65	.60	.65	.70
Nos.	11	12	13	14	16
Yards,	20	25	30	40	60

**CLICK.**

Each,	.65	.70	.75	.80	.85	.90
Nos.	21	22	23	24	2	7
Yards,	20	25	30	40	60	80

**Polished Brass, Not Multiplying.**

**WITH CLICK.**

Each,	.85	.90	.95	1 05	1 15	1 20
Nos.	31	32	33	34	36	37
Yards,	20	25	30	40	60	80

**WITH CLICK, BUSHED.**

Each,	1 30	1 40	1 50	1 80	2 00
Nos.	42	43	44	46	47
Yards,	25	30	40	60	80

**WITH CLICK.**

Handle Revolving within, and protected by rim.

**Plate 48.**

Each,	1 30	1 45	1 60	1 80	2 00	2 25
Nos.	031	032	033	034	036	037
Yards,	20	25	30	40	60	80

**SAME, BUSHED.**

Each,	1 60	2 00	2 25	2 50	2 75	3 00
Nos.	041	042	043	044	046	047
Yards,	20	25	30	40	60	80

**WITH STOP.**

**Plate 49.**

Each,	.55	.60	.65	.70	.75	.80
Nos.	51	52	53	54	56	57
Yards,	20	25	30	40	60	80

**BALANCE HANDLE.**

**Plate 50.**

Each,	.75	.90	1 00	1 15
Nos.	72	74	76	77
Yards,	25	40	60	80

**Polished Brass, Multiplying.**

**CRANK HANDLE, WITH DRAG.**

**Plate 51.**

Each,	1 25	1 35	1 45	1 60	1 80
Nos.	62	63	64	66	67
Yards,	25	30	40	60	80

**BALANCE HANDLE, WITH DRAG.**

**Plate 54.**

Each,	1 60	1 75	1 90	2 00	2 25	2 50
Nos.	192	193	194	196	197	198
Yards.	25	30	40	60	80	100

**EXTRA FINE BALANCE HANDLE.**

**Plate 52.**

Each,	1 75	2 00	2 25	2 50	3 00	3 75	4 25
Nos.	92	94	96	97	98	99	99½
Yards,	25	40	60	80	100	150	200

**Patent Compensating Steel Pivot Balance Handle.**

**Plate 53.**

Reels become quickly worn at the bearings of the spool and gearing, and as usually constructed, are expensive to repair when so worn. The object of our invention is to provide for adjustment of the bearings.

so that any wear can be readily compensated, and the reels kept in good condition without expense; and to that end it consist in screw pivots combined with the reel as shown in Plates 53 and 63.

**DOUBLE MULTIPLYING, NICKEL PLATED, WITH ADJUSTABLE CLICK.**

Each,	4 00	4 50	5 00	5 50	6 00
Nos.	94 C	96 C	97 C	98 C	99 C
Yards,	40	60	80	100	150

**Extra Fine "Imbrie" Black Bass.**  
 Patent Compensating Steel Pivot Balance Handle; Double Multiplying; German Silver Spool, Adjustable Click. The best Black Bass Reel in the World.

**Plate 60.**

Each,	11 00	12 00	14 00	16 00
Old Nos.	4	3	2	1
New "	486	488	489	489 1/4
Yards,	60	100	150	200

Patent Compensating Steel Pivot Balance Handle, Quadruple Multiplying; Nickel Plated, with Slide Click and Drag.

**Plate 62.**

Each,	9 00	9 50	10 00
Nos.	0204 C	0206 C	0207 C
Yards,	40	60	80

Those Anglers who prefer a reel which Multiplies only twice are unanimous in their verdict that the "Imbrie" is the most perfect reel ever made, while those who prefer a reel which Multiplies more rapidly, agree that this Quadruple is a revelation of how perfect a reel can be.

**Polished German Silver, Multiplying.**

**EXTRA FINE BALANCE HANDLE.**

Each,	4 00	4 50	5 00	5 50	
Nos.	112	114	116	117	
Yards,	25	40	60	80	
Each,	6 00	7 00	8 50	10 00	12 00
Nos.	118	119	119 1/4	119 1/2	119 3/4
Yards,	100	150	200	250	300

**Hard Rubber, Polished.**

**BRASS SPOOL, CLICK.**

Not Multiplying.

**Plate 55.**

Each,	2 00	2 25	2 50
Nos.	84	86	87
Yards,	40	60	80

**Brass Spool, Bushed, Click.**

Not Multiplying.

Each,	2 50	2 75	3 00
Nos.	84 B	86 B	87 B
Yards,	40	60	80

**Nickel Plated Spool, Click,**

Not Multiplying; with bands around discs.

**Plate 55.**

Each,	3 00	3 50	4 00
Nos.	184	186	187
Yards,	40	60	80

**Extra Fine "Abbey," Click.**

**Plate 56.**

Not Multiplying; German Silver Bands around discs, with handle revolving beneath rim.

Each,	6 00	6 50	7 50	8 50	10 00
Old Nos.	5	4	3	2	1
New "	384	386	388	389	389 1/4
Yards,	40	60	100	150	200

**Abbey (2d Quality) Nickel Plated.**

Each,	4 00	4 50	5 00
Nos.	284	286	287
Yards,	40	60	80

**Revolving Disc, Nickel Plated Spool.**

**Plate 57.**

Each,	4 00	4 25	4 75
Nos.	584	586	587
Yards,	40	60	80

**Extra Fine Pillar.**

**HARD RUBBER AND GERMAN SILVER.**

**Plate 58.**

Each,	8 00	10 00	12 00
Nos.	684	686	688
Yards,	40	60	100

**Best Hard Rubber and German Silver Salmon Reel.**

**Plate 59.**

Patent Screw Brake.....each, 30 00

**Nickel Plated Quadruple Multiplying.**

PRICES INCLUDE CLICK AND DRAG.

**Plate 61.**

Each,	5 50	6 00	6 50
Nos.	094	096	097
Yards,	40	60	80

**Cuttyhunk, Steel Pinion, Multiplying.**

**GERMAN SILVER, WITH SLIDE DRAG.**

Each,	20 00	22 00	24 00
Old Nos.	1	1/0	2/0
New "	689 1/4	689 1/2	689 3/4
Yards,	200	250	300

**HARD RUBBER, WITH SLIDE DRAG.**

Each,	20 00	22 00	24 00
Old Nos.	1	1/0	2/0
New "	789 1/4	789 1/2	789 3/4
Yards,	200	250	300

Extra Quality Patent Bridge Action, Hard Rubber and German Silver, Full Steel Pivot and Steel Pinion.

No. 2/0.....each 35 00  
 Yards, 300

**Fowler Patent Hard Rubber.**

**Plate 64.**

Each,	3 00	3 25
Yards,	40	60



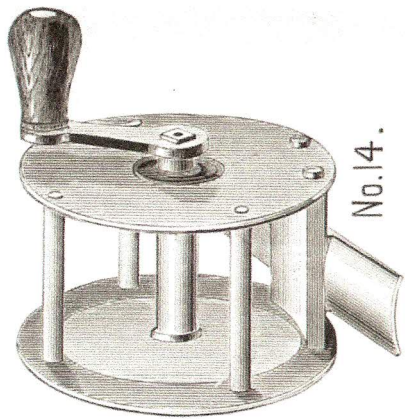

No. 14.

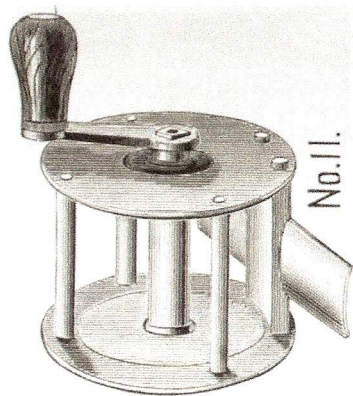

No. 11.

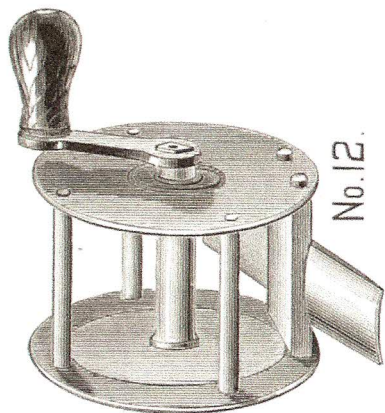

No. 12.

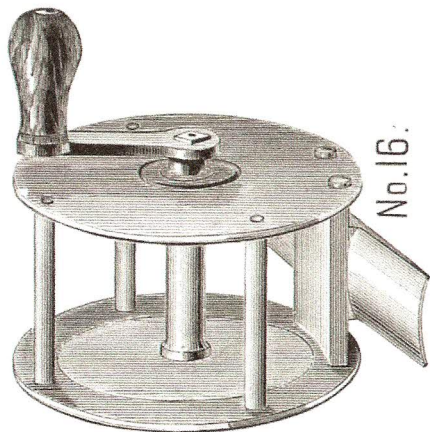

No. 16.

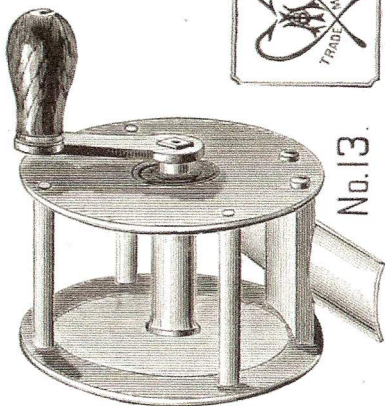

No. 13.



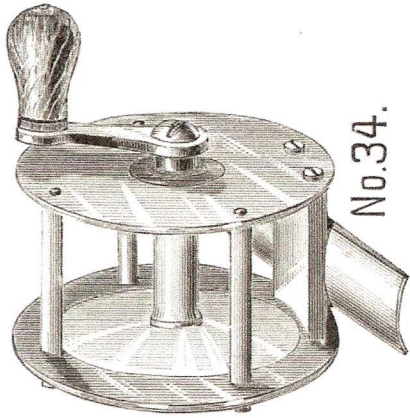

No. 34.

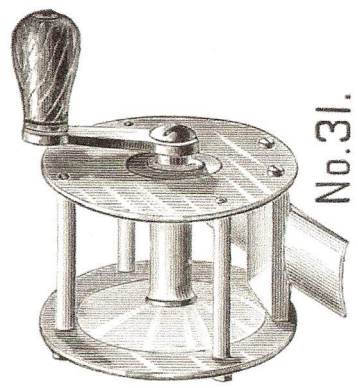

No. 31.

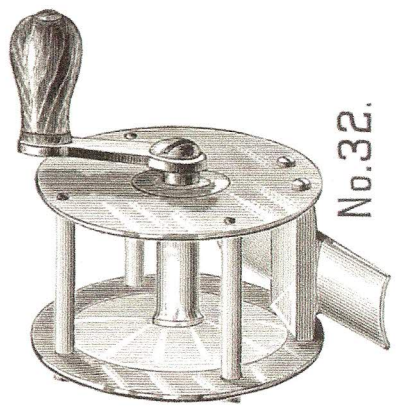

No. 32.

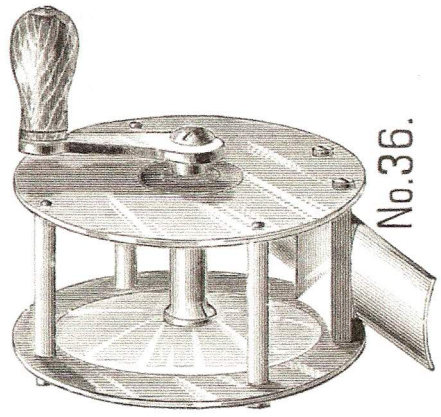

No. 36.

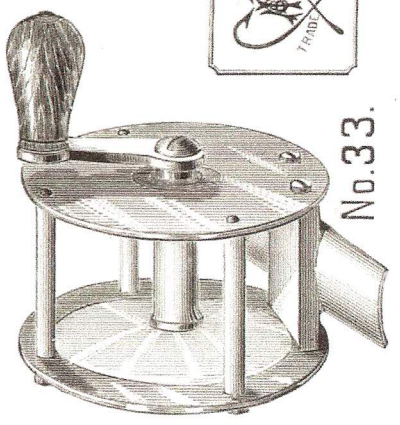

No. 33.





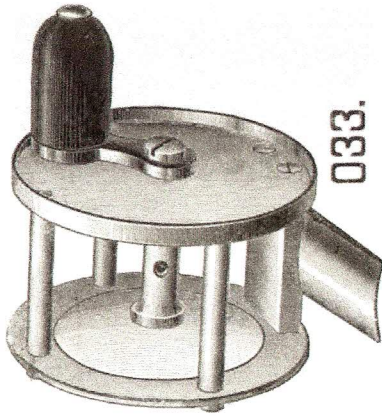
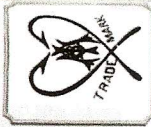

033.

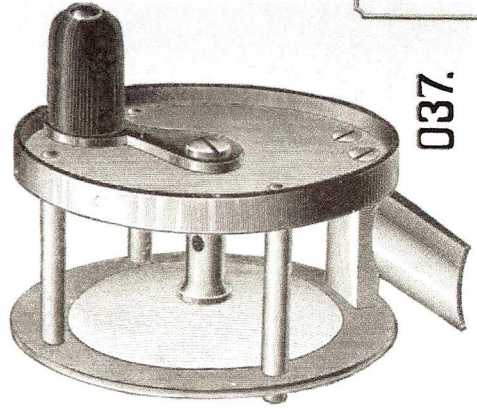

037.

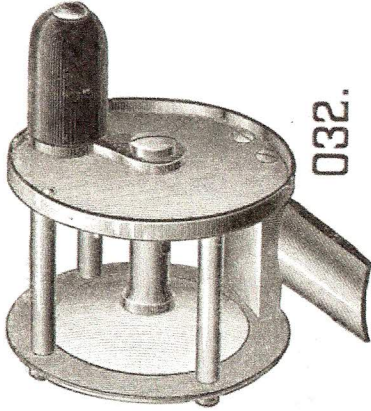

032.

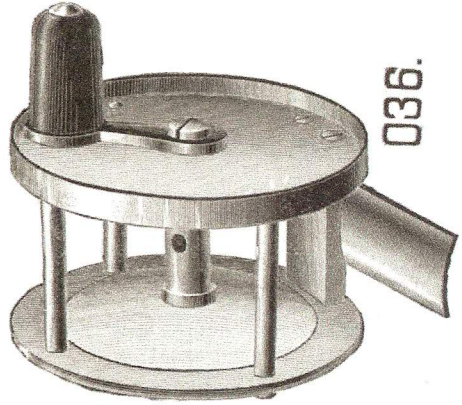

036.

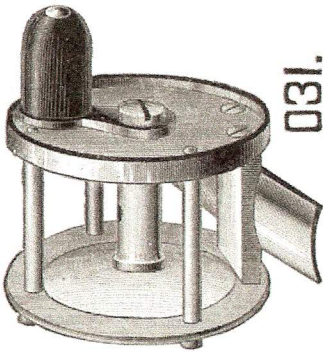

031.

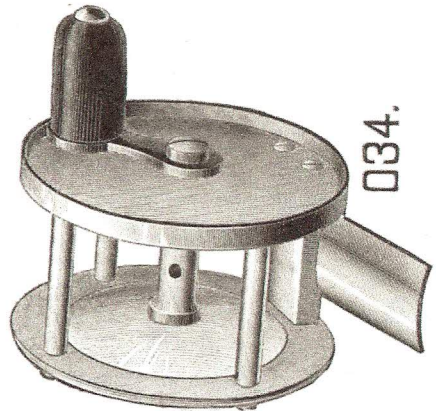

034.

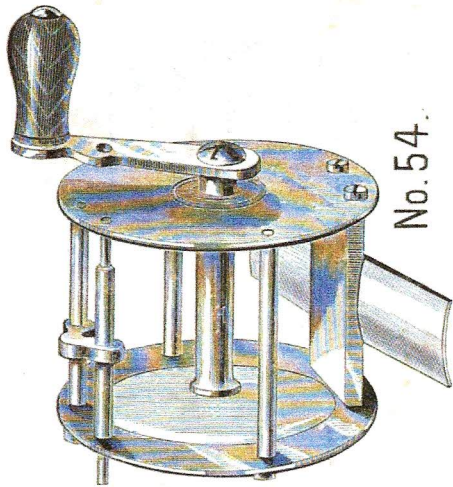

No. 54.

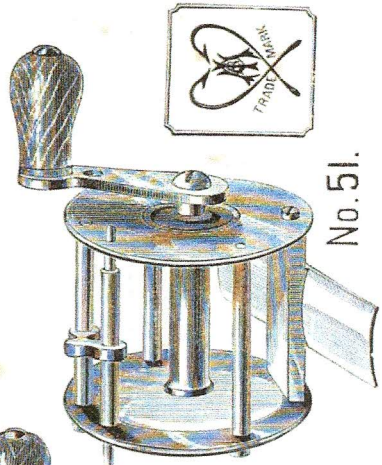

No. 51.

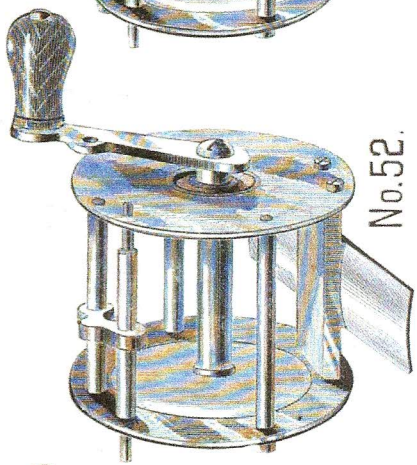

No. 52.

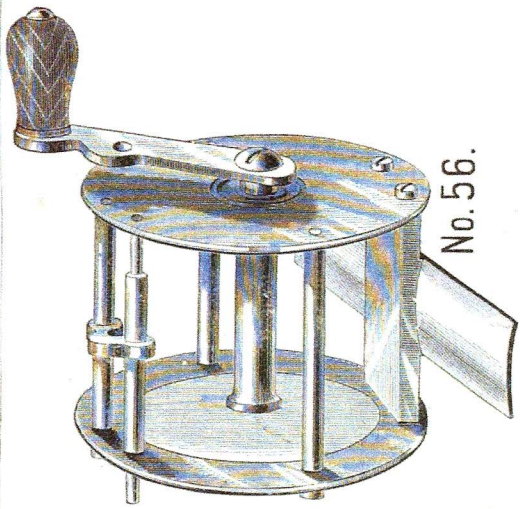

No. 56.



No. 53.



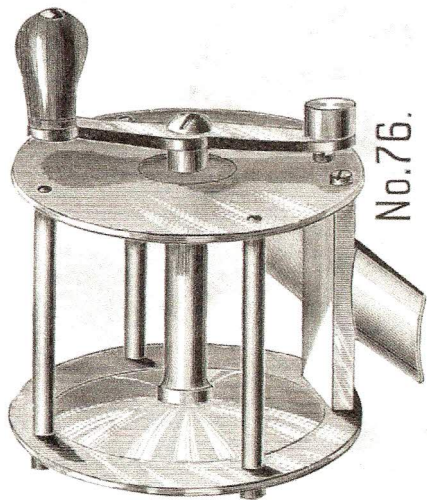

No. 76.

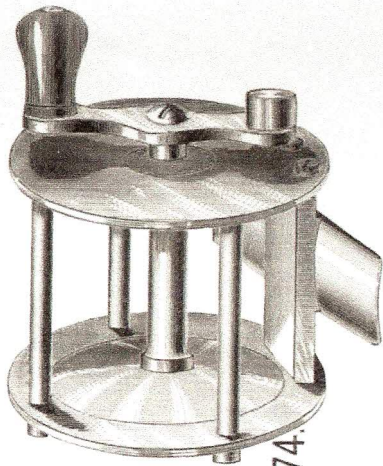

No. 74.

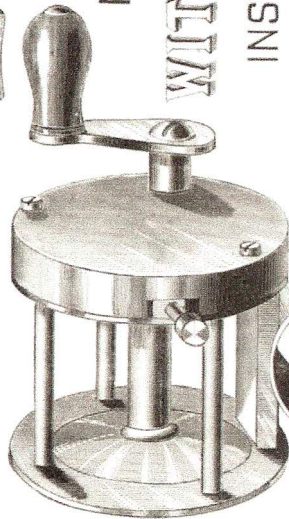

No. 62.

WITH RING

INSTEAD OF

PLATE.

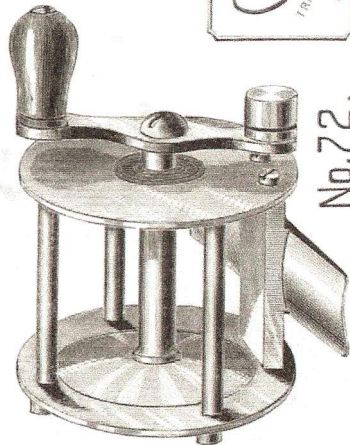
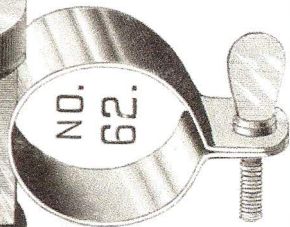

No. 72.

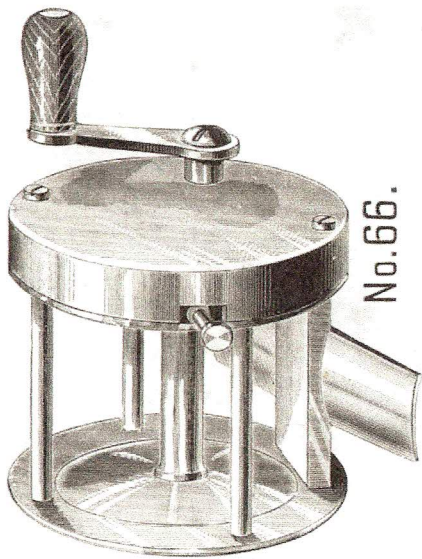

No. 66.

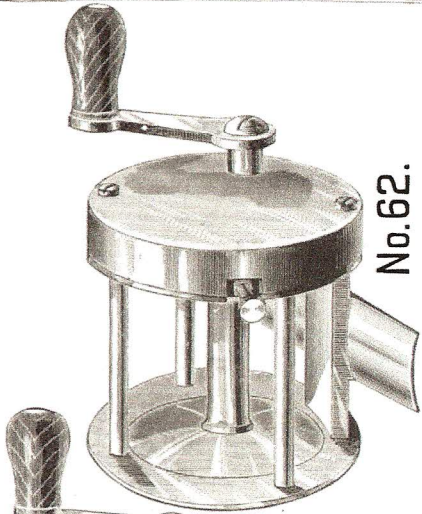

No. 62.

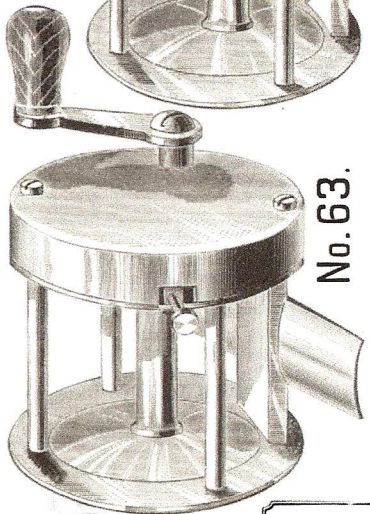

No. 63.

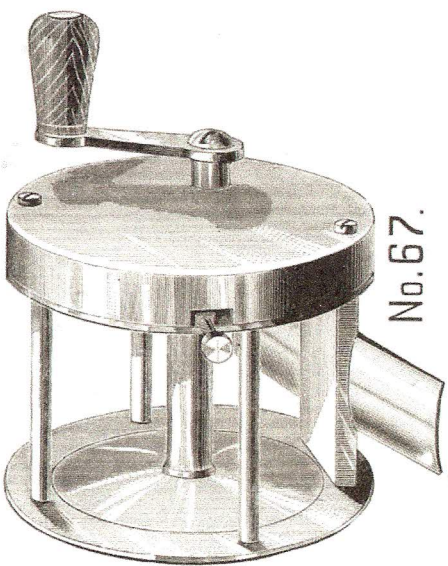

No. 67.

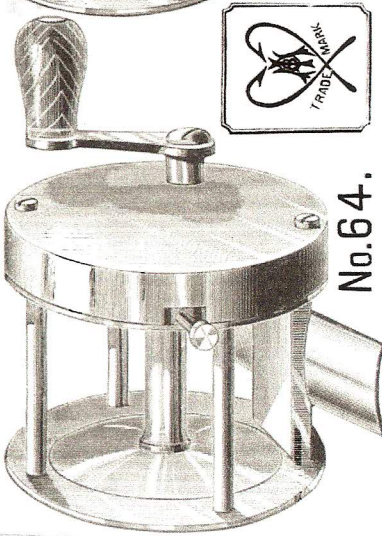

No. 64.

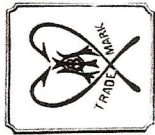



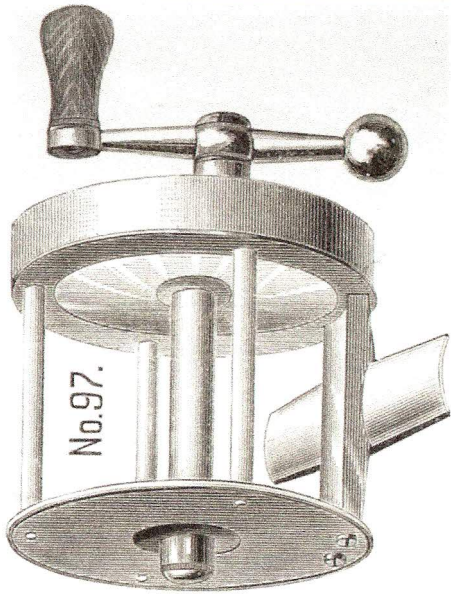

No. 97.

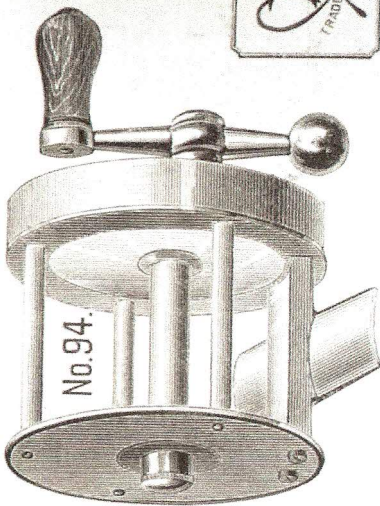

No. 94.

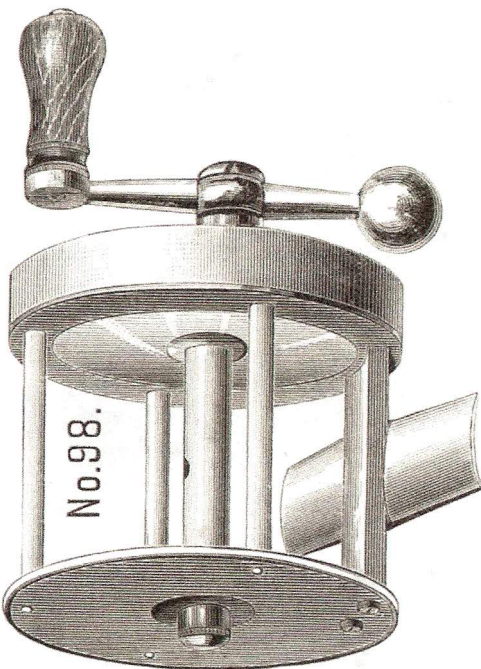

No. 98.

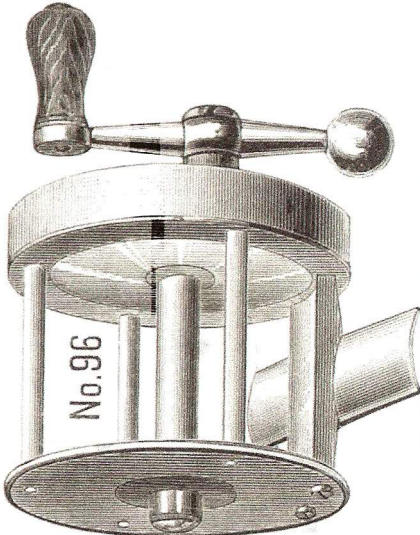

No. 96.

# PATENT COMPENSATING STEEL PIVOT

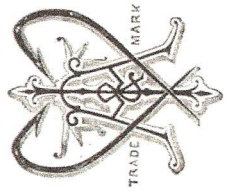

# ABBEE & IMBRIE'S

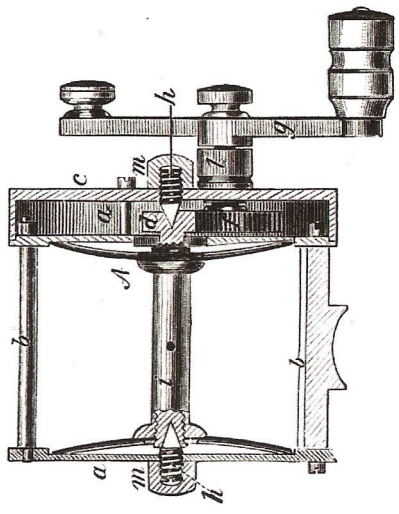

SECTION.



COMPENSATING  
STEEL PIVOT.

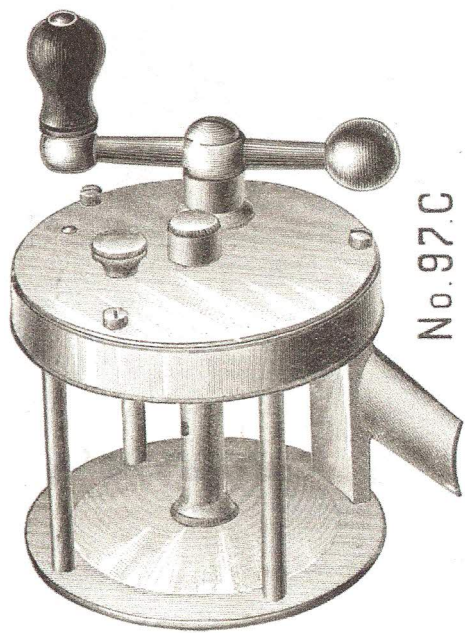

No. 97.C

DUPLEX.



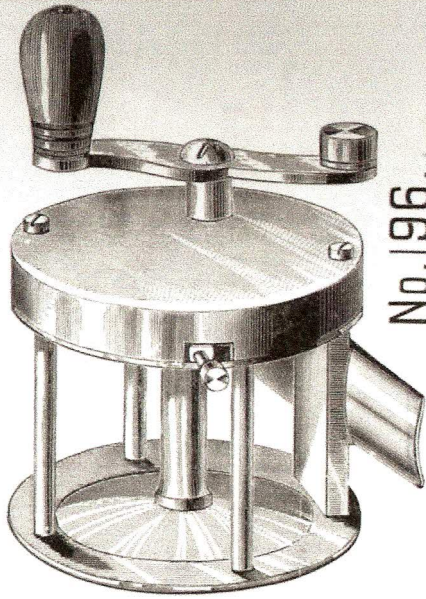

No. 196.



No. 192.

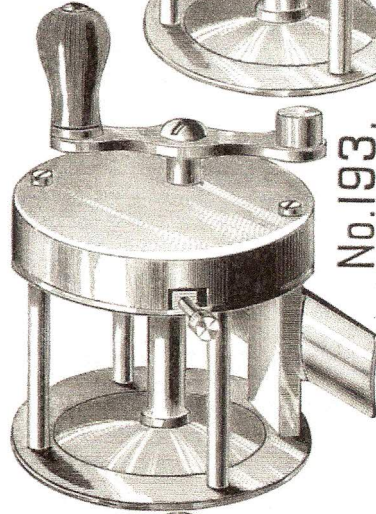

No. 193.

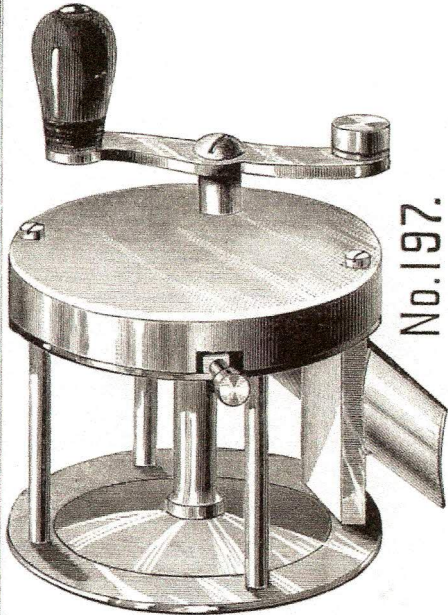

No. 197.

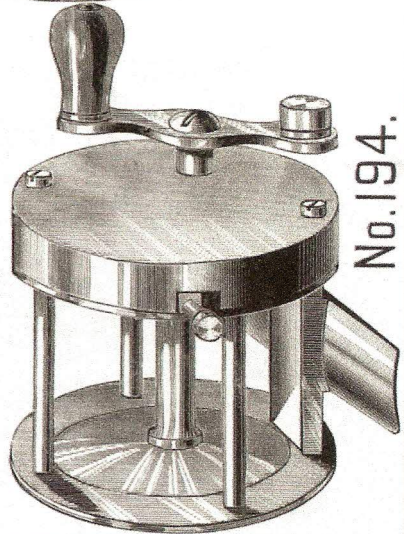

No. 194.



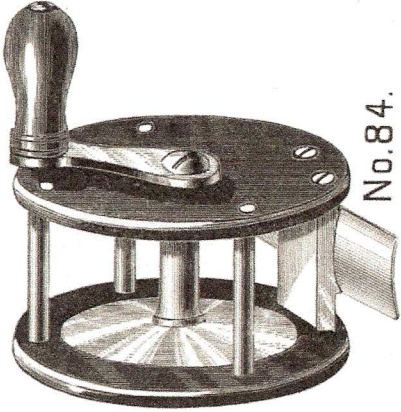

No. 84.

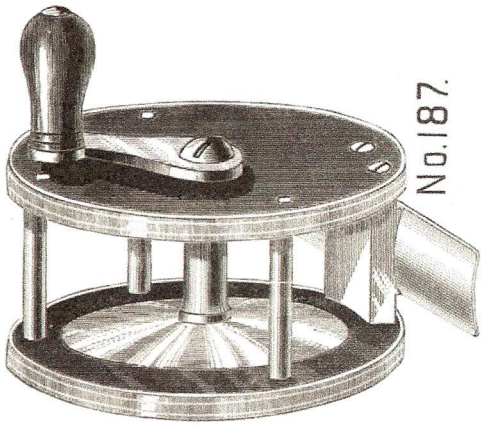

No. 187.

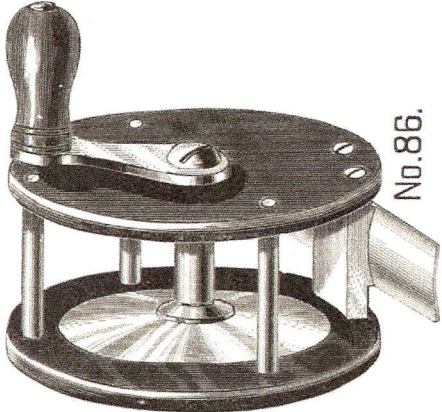

No. 86.

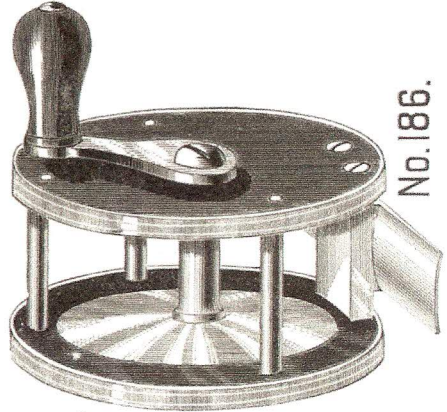

No. 186.

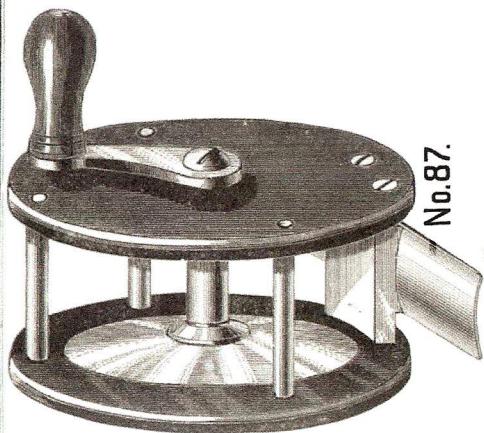

No. 87.

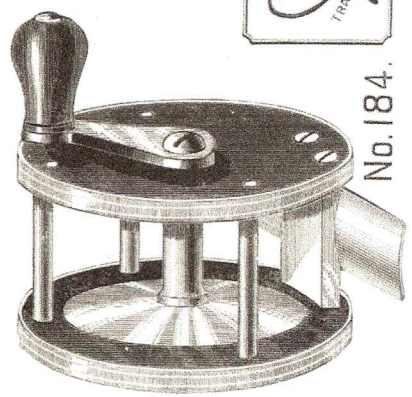

No. 184.





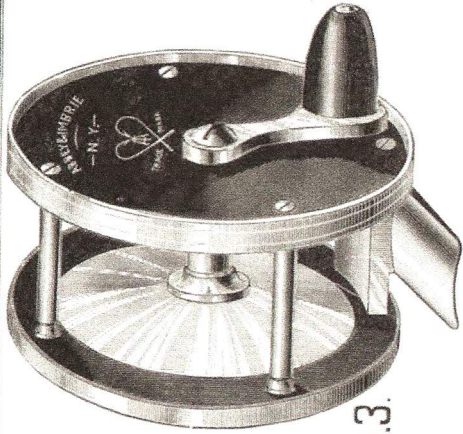

No. 3.

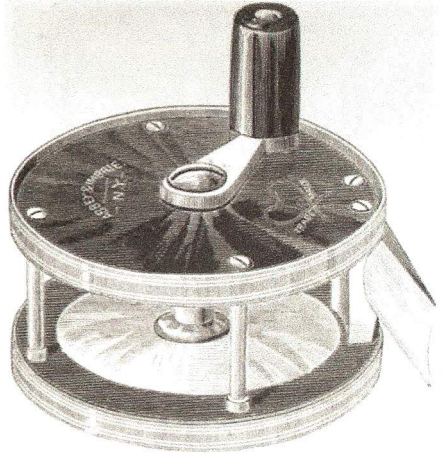

No. 4

THE  
"ABBAY & MOORE"  
"TRADE MARK"

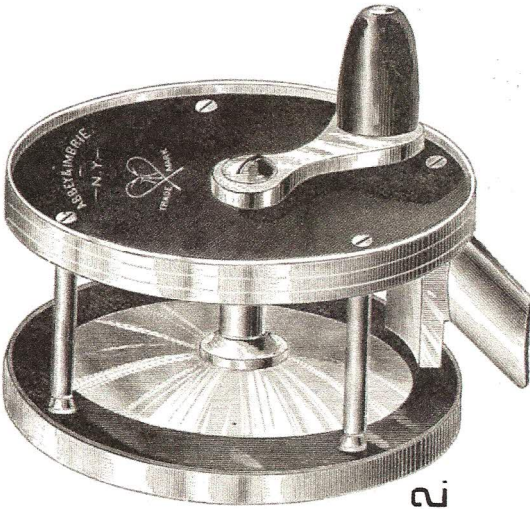

No. 2.

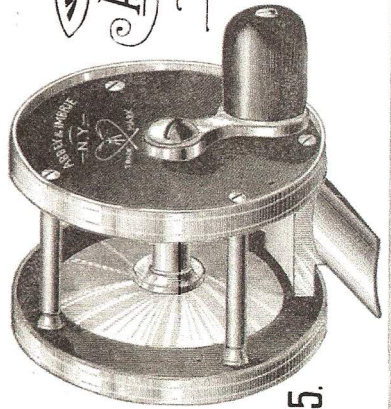

No. 5.



No. 587

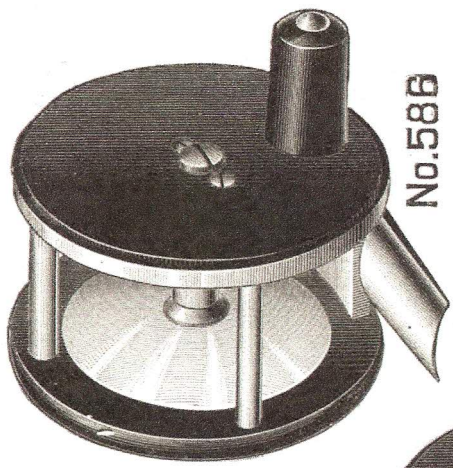

No. 586

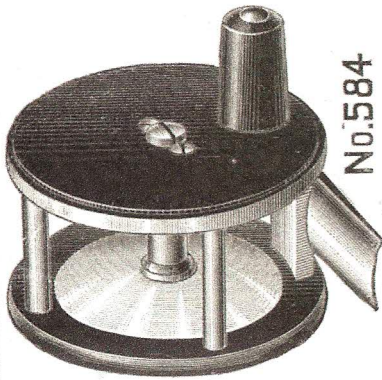

No. 584

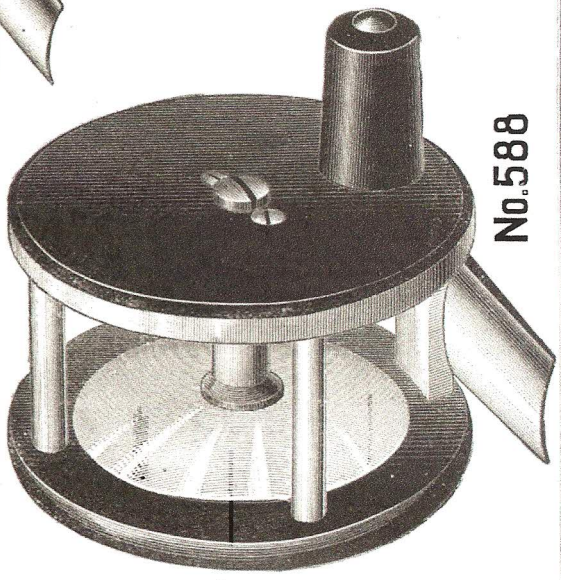

No. 588

# REVOLVING DISK





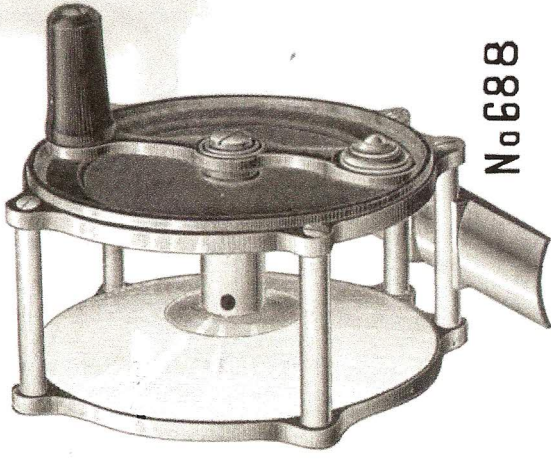

No 688

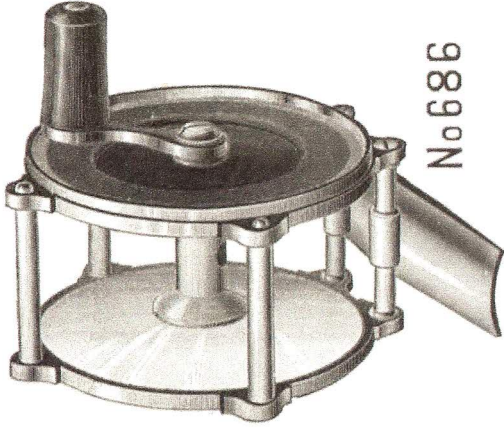

No 686

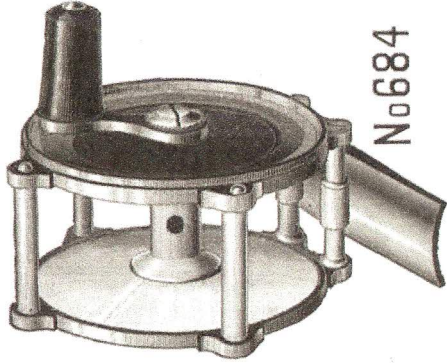

No 684

**EXTRA FINE PILLAR**



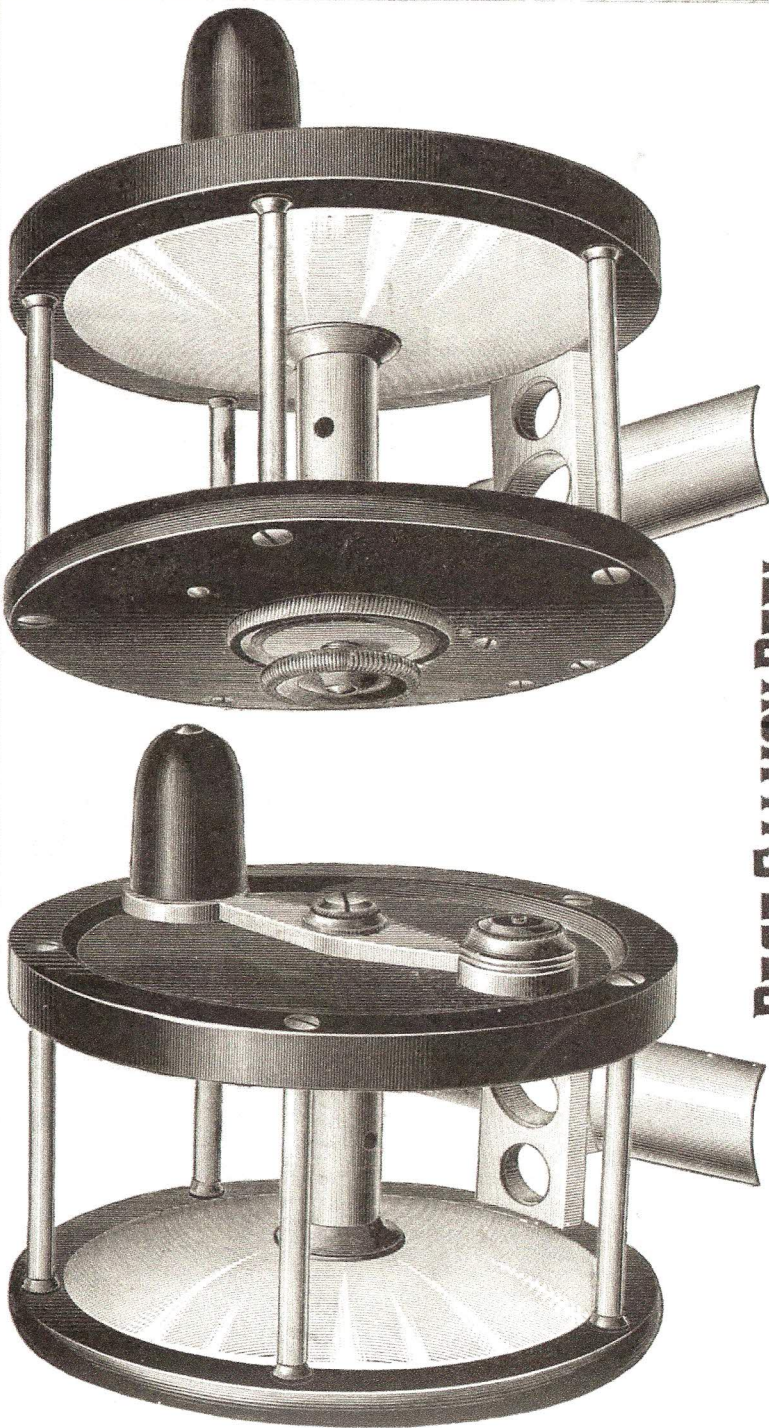

# BEST SALMON REEL

Pat. Jan'y. 17. 1882.





—“BLACK BASS”—

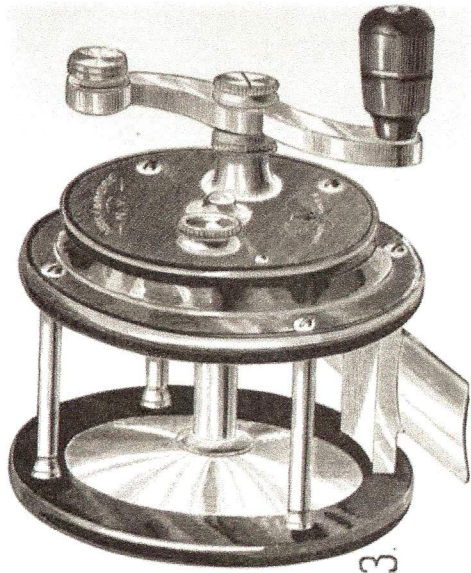

No. 3.

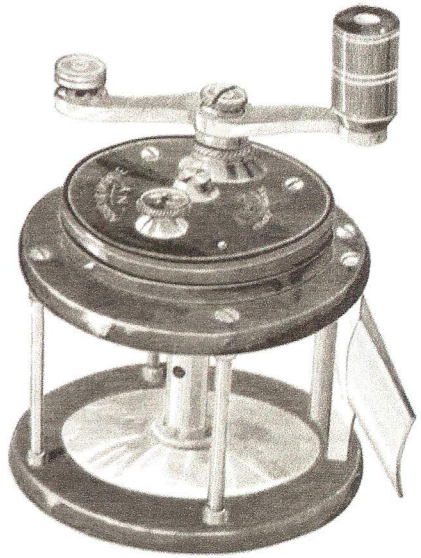

No. 4.

—THE IMBRIE—

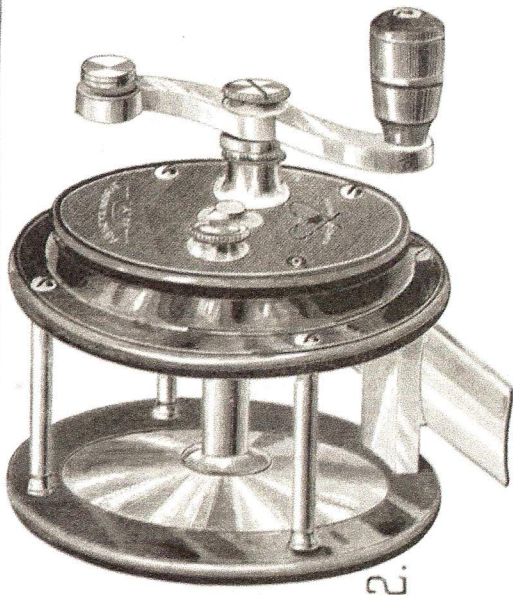

No. 2.

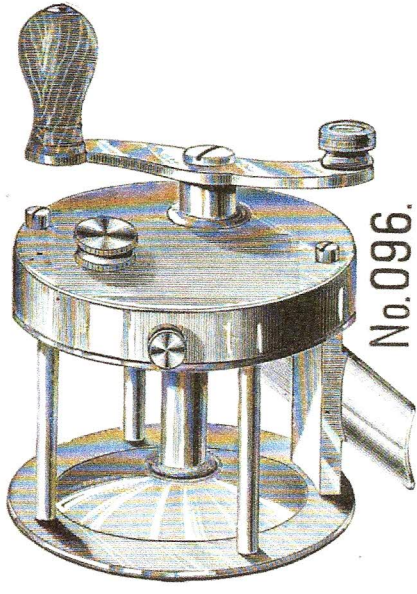

No. 096.

ALL QUADRUPLE

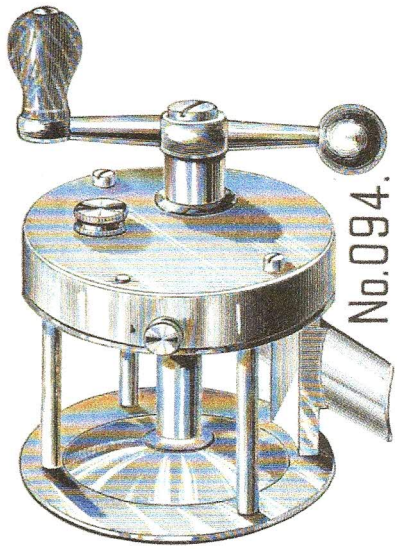

No. 094.

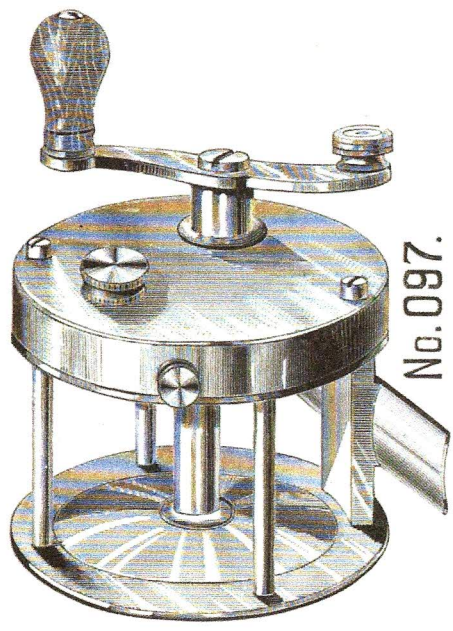

No. 097.





# PATENT QUADRUPLE STEEL PIVOT REEL

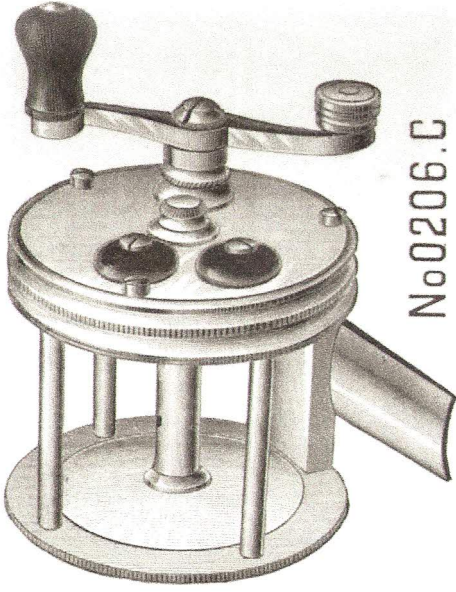

No 0206.C

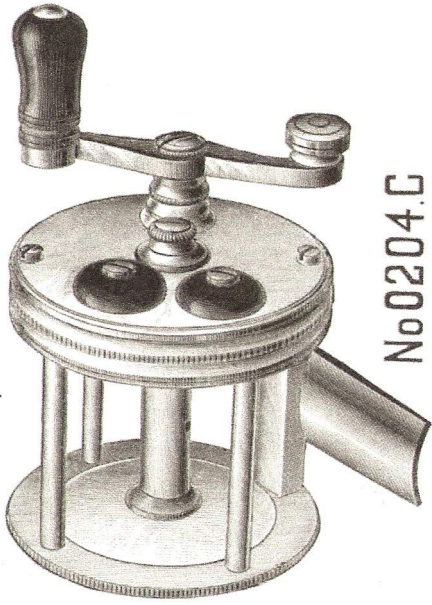

No 0204.C

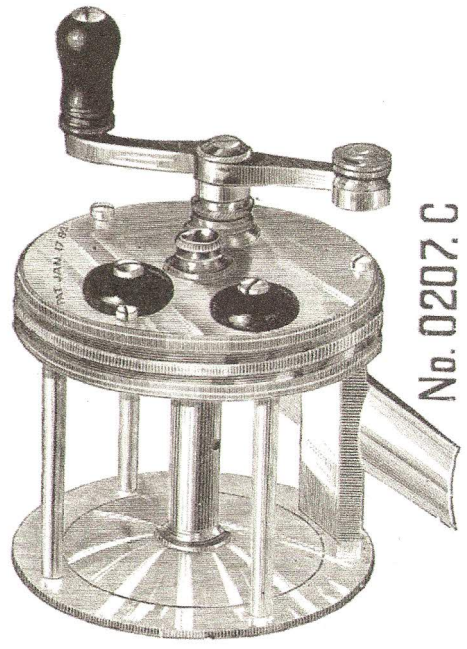

No. 0207.C

**PATENT**  
**COMPENSATING**  
**STEEL PIVOT**

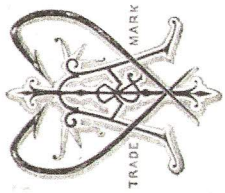

**ABBIEY**  
**&**  
**IMBRIE'S**

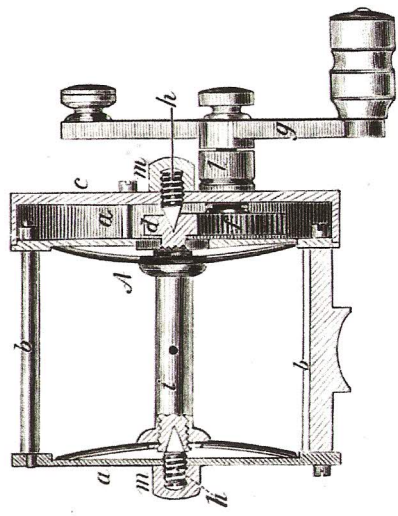

SECTION.



**COMPENSATING**  
**STEEL PIVOT.**

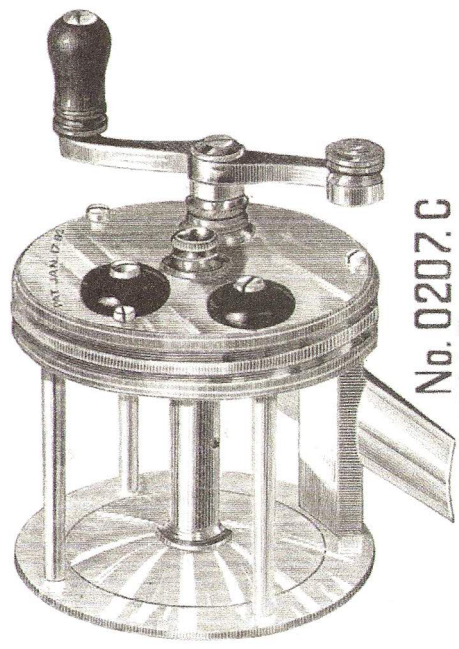

**No. 0207.C**  
**QUADRUPLE.**



# THE ROWLER REEL

PAT. JUNE, 1872.

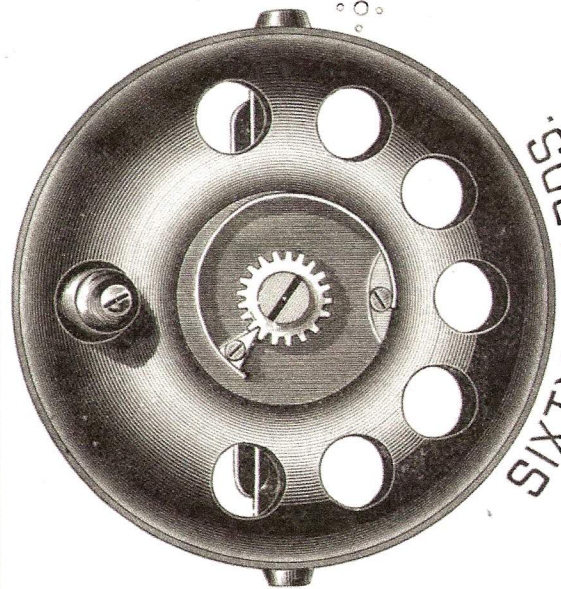

SIXTY YARDS.

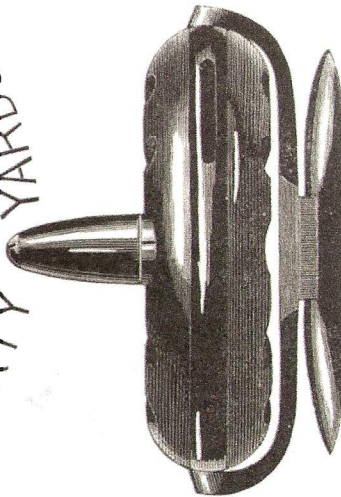

FORTY YARDS, SIDE VIEW.

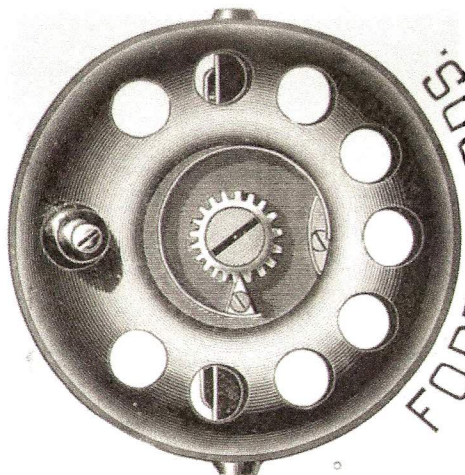

FORTY YARDS.

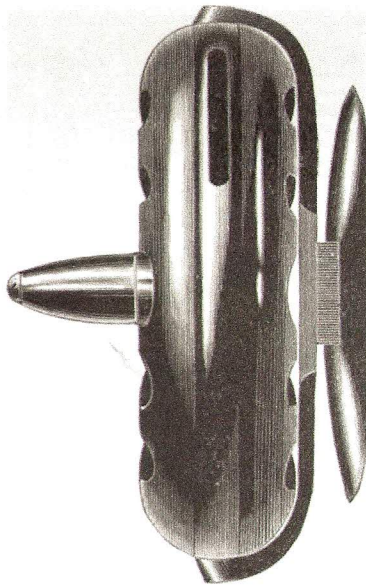

SIXTY YARDS, SIDE VIEW.



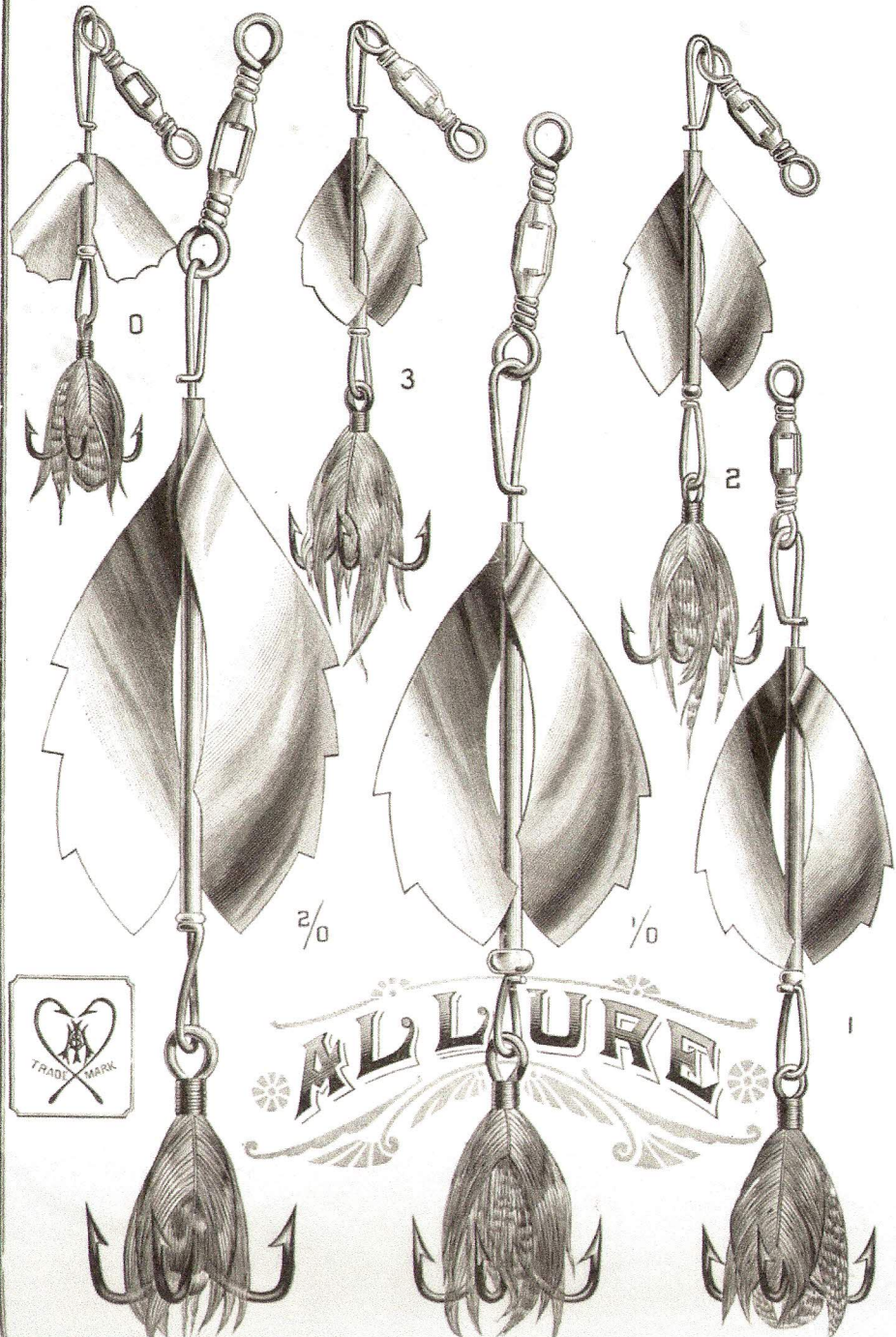

ALLURE



PERFECT REVOLVING.

FANCY ALLURE.

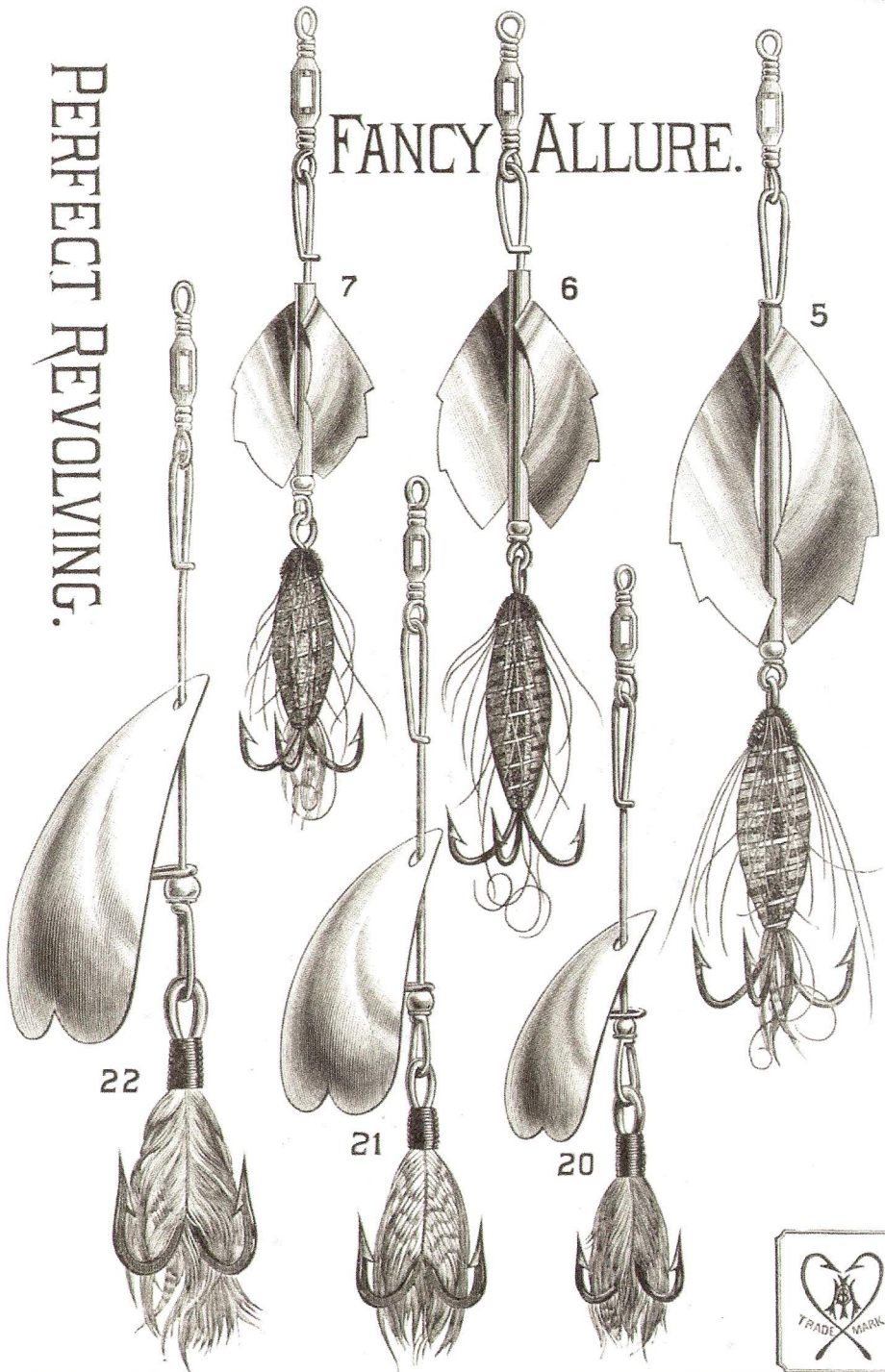

Devon or Angel.

7

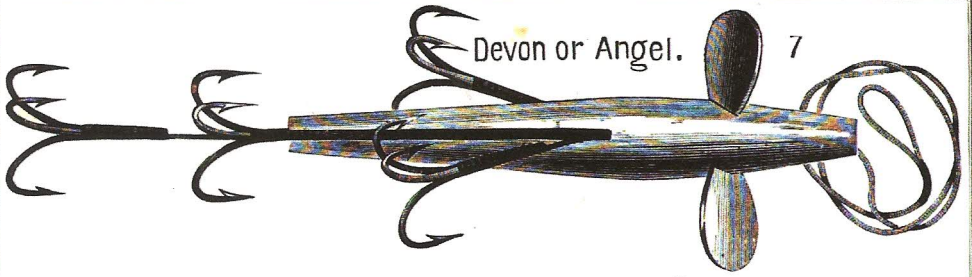

Fancy Jointed

4

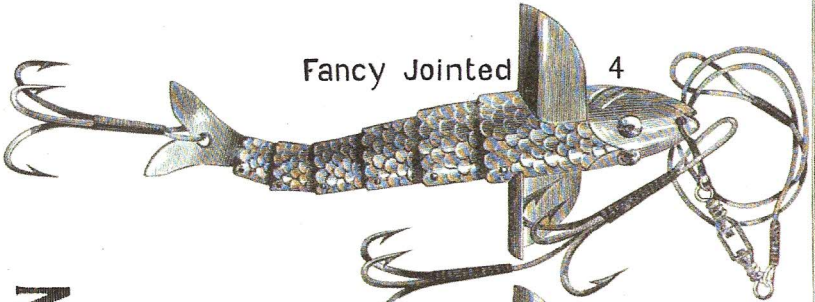

Minnows.

Fancy Hollow

184

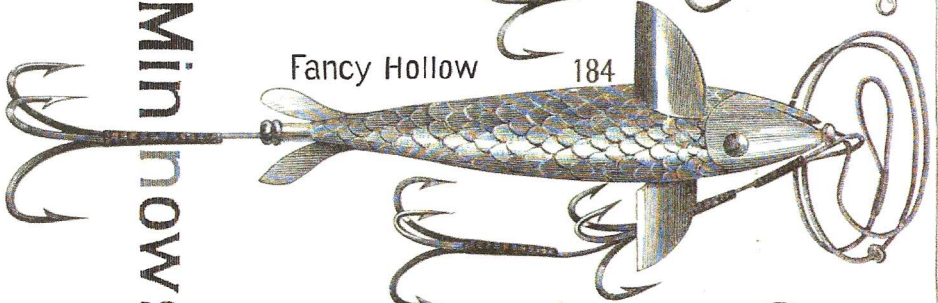

Plain Jointed

4

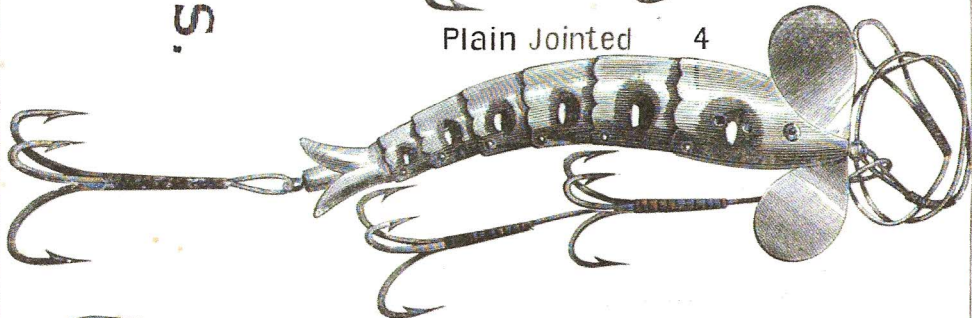

Fancy Solid

389





*Phantom. 7.*

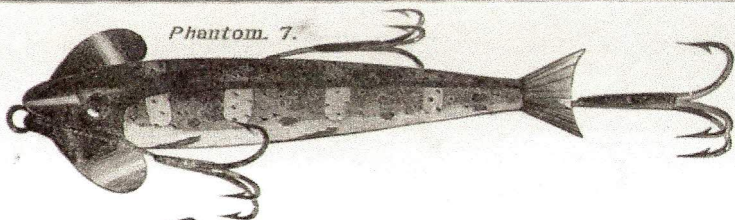

*Protean. 7.*

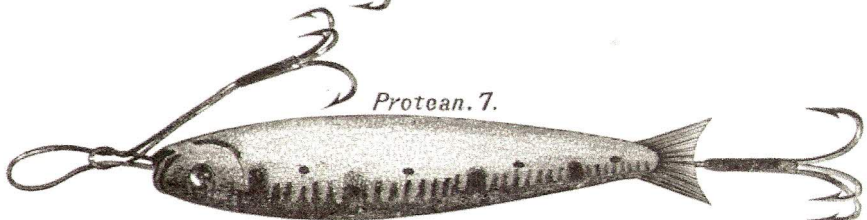

*Caledonian Extra. 7.*

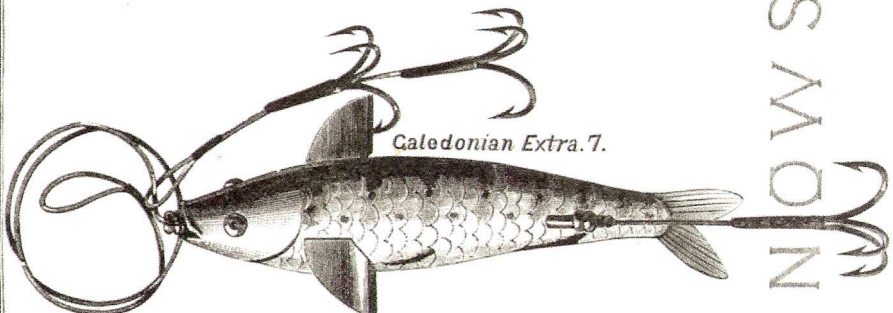

*Caledonian. 7.*

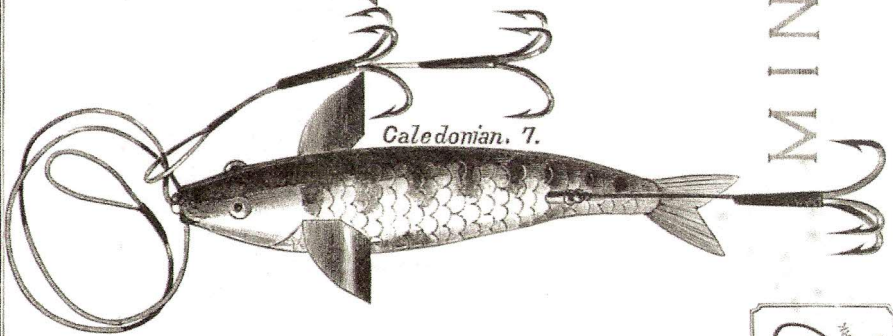

*Metal Eel. 4.*

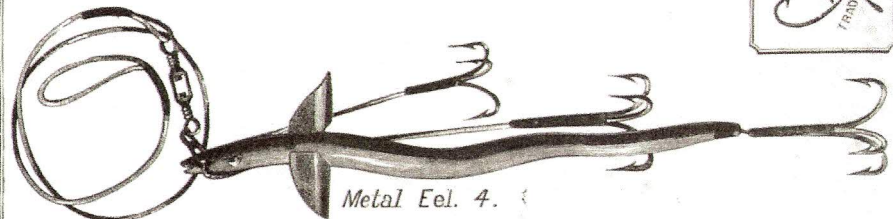

MINNOWS.



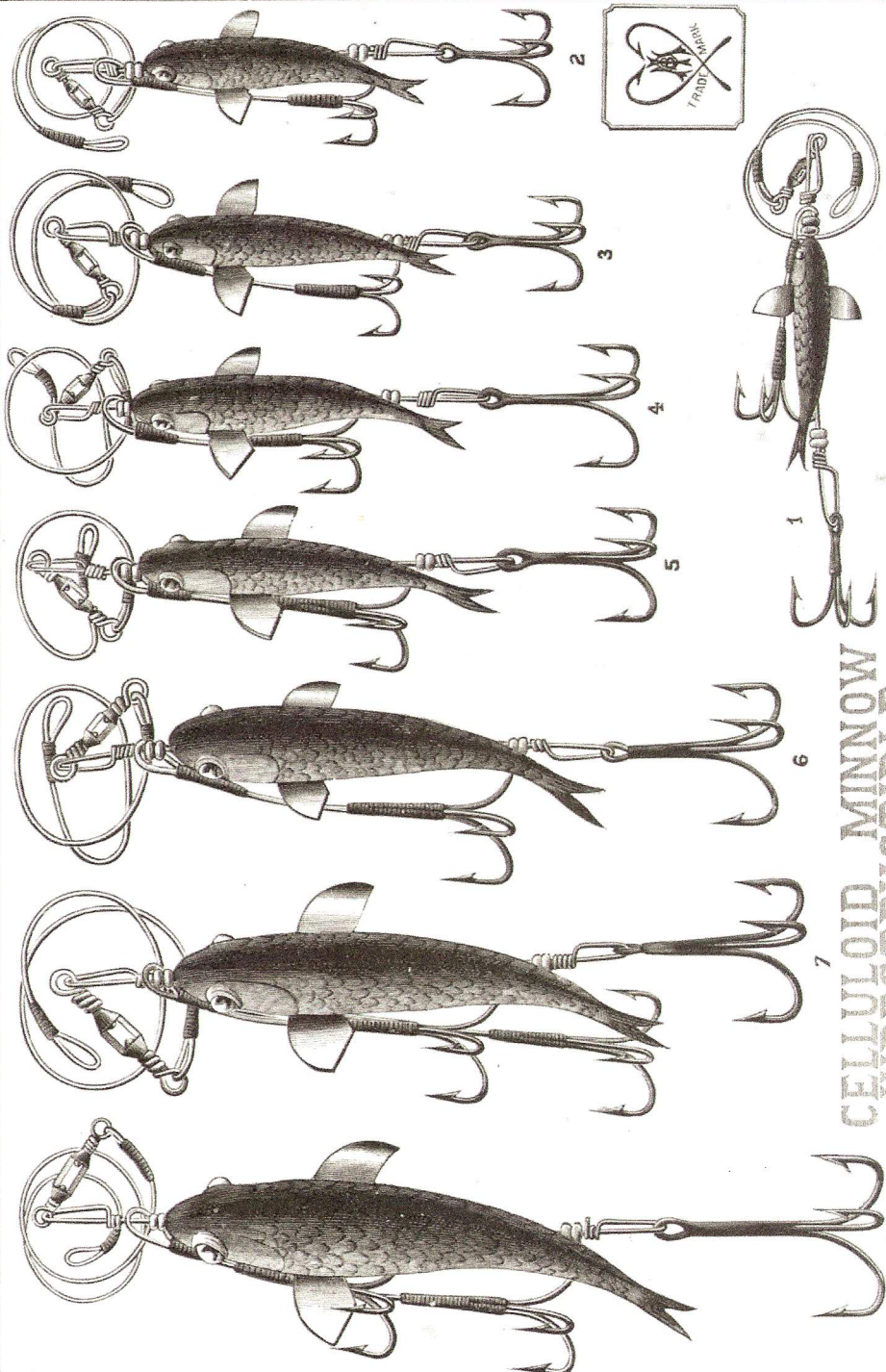

CELLULOID MINNOW  
INDESTRUCTIBLE