

Fishing Collectibles *Magazine*

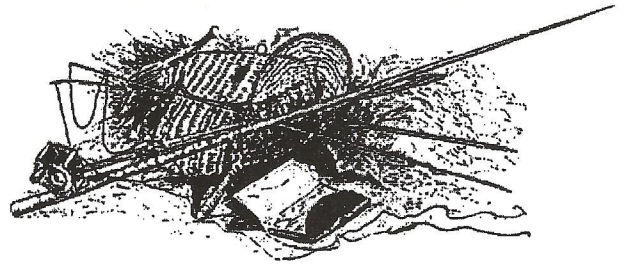

FALL 1992 ISSUE

VOLUME FOUR NUMBER TWO

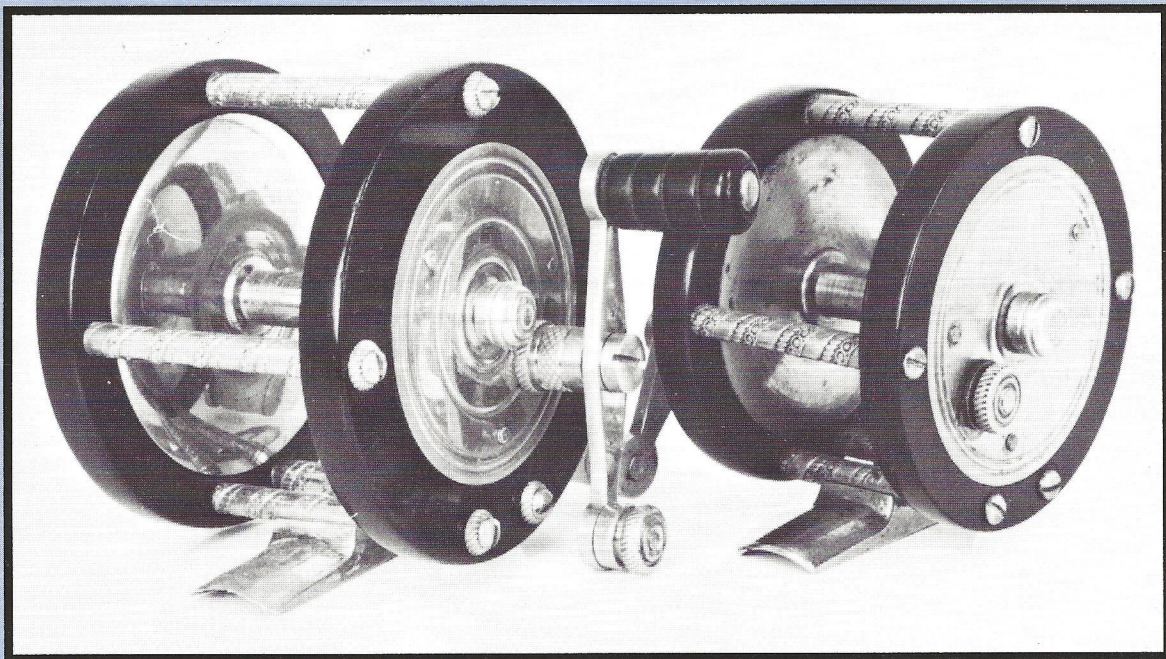

Augustus D. Hendrick and the Star Reel Works: the Connecticut Connection

by *Steven K. Vernon*
and
Arnold W. Peterson, Jr.

Although many of the finest reels of the nineteenth century were manufactured in New York and Kentucky, few anglers could afford the finely tuned German silver machines made by such craftsmen as the Meeks, the Milams, the vom Hofes, Gayle, and others in those states. To discover what kinds of reels the average fisherman purchased, one need merely thumb through the catalogs of the leading sporting-goods and hardware dealers of the day. Virtually all, from Abbey & Imbrie and William Mills & Son to Peck & Snyder and Hibbard, Spencer, Bartlett & Co., offered an enormous variety of rela-

WHITING & HENDRICK BROS.

MANUFACTURERS OF

FISHING RODS

REELS,

—AND—

ROD MOUNTINGS

97 1-2 Court Street, New Haven, Conn.

This advertisement for Whiting & Hendrick Bros. appeared in New Haven directories for both 1884 and 1885.

HENRY B. WHITING,
MANUFACTURER OF
FISHING RODS
Rod Fittings and Tackle
OF EVERY DESCRIPTION.
Myrtle Avenue, - Ansonia, Conn.

Whiting's advertisement in the Derby Directory for 1883-1884

tively inexpensive single-action and multiplying reels. Even these affordable reels varied in quality, of course; the cheapest were made of stamped and formed sheet metal, while others incorporated heavy castings and were equipped with gears and bearings adequate for years of service. These "Everyman" reels, some of which were priced as low as ten cents, were rarely identified in the catalogs. The astute collector sometimes can identify such reels through salient design features, but the manufacturers of most of these "trade" reels remain unidentified. Nevertheless, a growing body of evidence suggests that substantial numbers of the reels were made in the state of Connecticut.

Collectors are aware that the Horton Manufacturing Company, of Bristol, Connecticut, successfully mass-produced their "Meek" reels after purchasing B. F. Meek & Sons, of Louisville, in 1916. The Liberty

Bell Company, also of Bristol, implemented Edward Rockwell's ingenious reel designs during the first decade of the twentieth century. The Andrew B. Hendryx Company, of New Haven, flooded the country with relatively inexpensive brass reels for decades. In Torrington, the Union Hardware Company continued that tradition.

The companies mentioned above proudly marked most of their products. In contrast, the Terry Clock Company, of Waterbury, Connecticut, manufactured a surprisingly varied line of reels in both brass and German silver during the 1870's, but we are not aware of any marked with the Terry name. While the many reels equipped with Silas Terry's patented reel foot are easily recognized, those fitted with conventional feet usually remain unidentified. Yet the company continued to manufacture trade reels even after its sale at bankruptcy and

WHITING & HENDRICK BROS.,

Successors to H. B. WHITING,



97 1-2 COURT STREET,

NEW HAVEN, CONN.,

H. B. WHITING.

A. D. HENDRICK.

G. W. HENDRICK.

A Whiting & Hendrick Bros. trade card (Courtesy of American Museum of Fly Fishing)

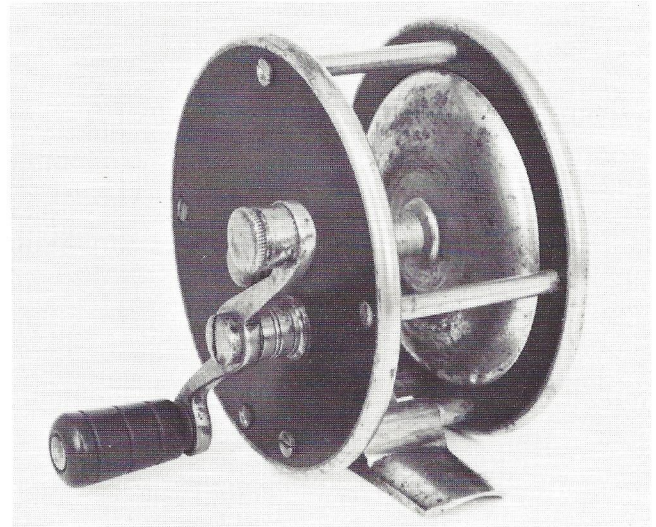
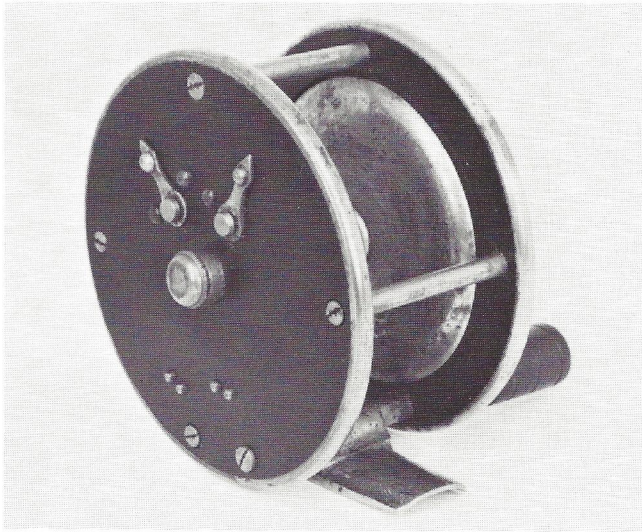

The front and back of a Whiting & Hendrick Bros. multiplying reel. Made of plated brass and hard rubber, the reel is marked "PAT APL'D FOR," but we believe that no such patent was granted. The reverse-S crank has a rubber knob with three grooves. The back has arrow-shaped levers for the click and drag.

removal to Pittsfield, Massachusetts, in 1880, and probably until its discontinuance in 1893.

During the 1890's, Birmingham, Connecticut, was home to a now-obscure firm called The Star Reel Works. Located at the confluence of the Naugatuck and Housatonic Rivers within a few miles of Long Island Sound, Birmingham no longer exists officially, but she and her neighbors, which included New Haven and Bridgeport, comprised a sizable market for fishing equipment. The proximity of such giants as the Ansonia Brass & Copper

Company ensured that the few raw materials used in reelmaking would be available. More importantly, that section of Connecticut had long been known for its many major manufacturers of clocks and watches, which accounted for a relatively high proportion of skilled machinists within the local labor force.

Chartered in 1851, Birmingham was an industrial borough in the town of Derby, which had been settled in 1654; Derby and another borough, Ansonia, were separately chartered as cities in 1893. The town

of Shelton lies directly across the Housatonic from Derby, and those political subdivisions have made difficult the research into the history of the Star Reel Works. Each town's libraries and city halls contain different types of records covering different periods. Tracing the movements of our leading characters requires searches through city, county, and state records stored in a multitude of libraries. Therefore, our story remains incomplete, but it provides an outline of the history of a small, surprisingly successful, late nineteenth-century manufacturer.

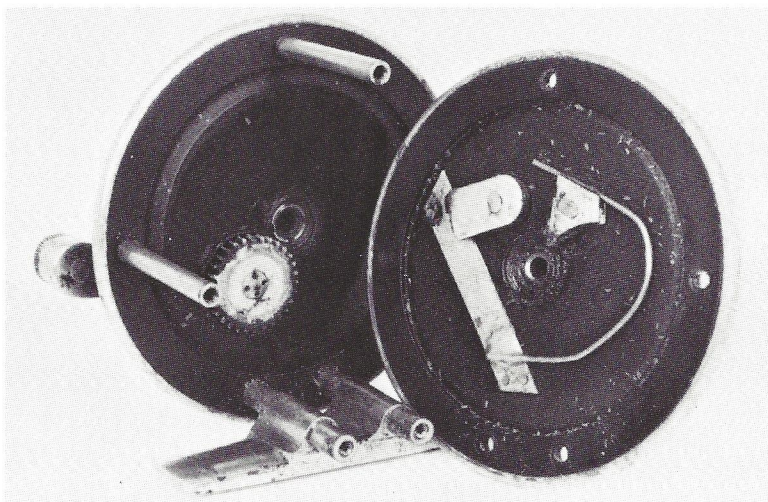

The inside of the Whiting & Hendrick Bros. reel and the one-piece machined foot. Note the swaging of the main gear.

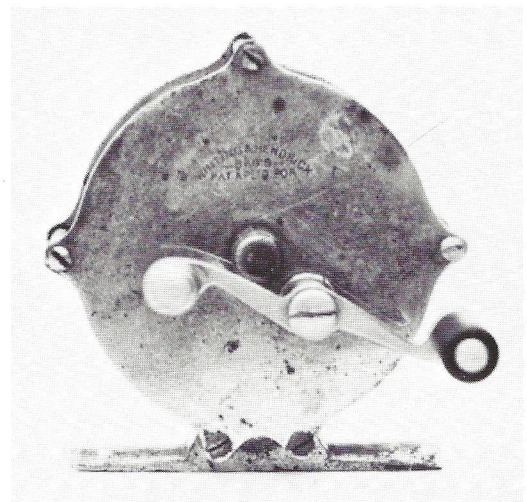

A raised-pillar style of Whiting & Hendrick Bros. reel made of plated brass. The markings, crank, and foot are similar to those of the rubber-and-brass reel. (Photo by Karl T. White)

(No Model.)

H. B. WHITING.
LINE HOLDER.

No. 338,212.

Patented Mar. 16, 1886.

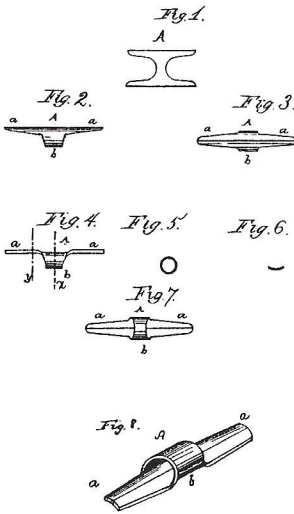

Whiting's one-piece, solderless rod guide patent drawings

HENDRICK BROS.,
— MANUFACTURERS OF —
FISHING RODS
REELS
ROD MOUNTINGS,
122 Court St., New Haven, Ct.

This advertisement in the New Haven Directory for 1886 indicates Whiting had sold out his share of the firm.

The dramatis personae of our story includes a rodmaker, a machinist, an entrepreneur, and a baseball player, among others. But the central character is, naturally, a reelmaker, whose career became intertwined with those of the other characters and led to the establishment of The Star Reel Works.

The story begins in 1879, when we encounter Augustus D. Hendrick, a clockmaker residing at 301 Orange Street in New Haven. Hendrick was born on June 17, 1832, in Forestville, an eastern section of Bristol. It is probable that he was

related to Ebenezer N. Hendrick, whose several Bristol firms, the first of which was located in Forestville, supplied clock movements to the Jerome Manufacturing Company until 1855. For over twenty years Augustus worked for the New Haven Clock Company, which had taken over the bankrupt Jerome firm, and he was considered "a skilful [sic], ingenious workman, being the inventor of several styles of clocks."¹ He was listed as a clockmaker from 1879 to 1884 in the *New Haven Directory*. In 1884, his household included his son, John A. Hendrick, an artist; his other children, Herman D., Herbert G., and Violetta, probably also lived with him but were too young to be named separately in a business directory. Exit Hendrick for the moment.

Enter Henry B. Whiting. In 1879, Whiting was listed as a fishing-rod manufacturer living on Tremont Street, Ansonia, by the *Derby Directory*. He had been listed similarly as early as 1868, although 1872-73 and 1875 directories labelled him only as "mechanic." Whether or not he was

A. D. HENDRICK,
— MANUFACTURER OF —
Fishing Reels
— AND —
GUIDES.
83 COURT ST., NEW HAVEN, CT.

By the time this advertisement appeared in the New Haven Directory for 1887, George Hendrick also had left the firm.

related to the Whiting of Atkins and Whiting, makers of 30-day clocks in Bristol until 1854, is not known. The failure of a number of important Connecticut clockmaking firms during the 1850's probably had been responsible for sending many skilled machinists into other fields of endeavor in other locations as they scurried to find alternate means of support. In any case, by 1881 Whiting was manufacturing fishing rods in a second-floor shop on Myrtle Avenue, Ansonia, and living at 52 Tremont with Washington Irving Whiting, his son, and Bela Whiting, probably another son. By the next year, Whiting moved to a house at 34 Central, where Adna Whiting (and, probably, W. Irving) also boarded. Bela joined them at the new address within another year or

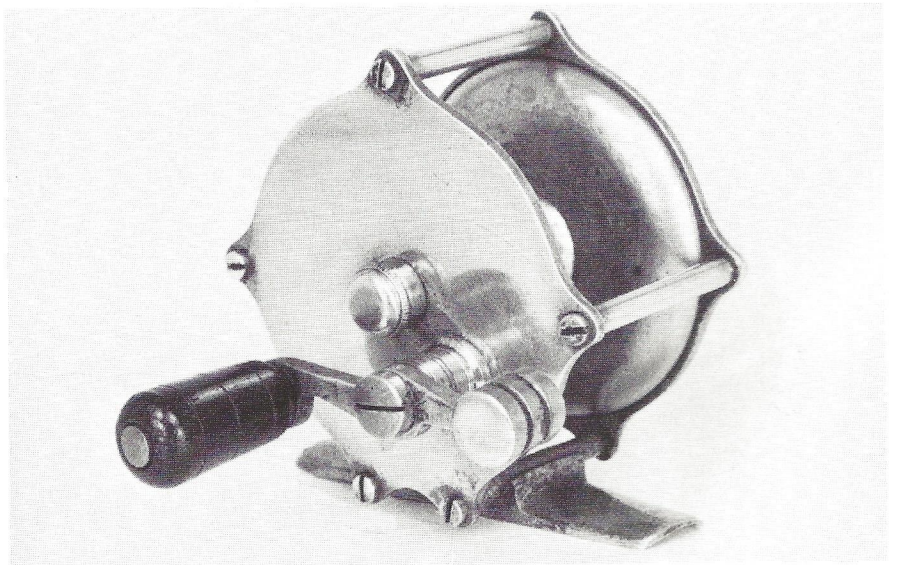

An unmarked reel similar to the Whiting & Hendrick Bros. raised-pillar reel. The reel also has two levers on the back for the click and drag. However, this reel's foot has been grooved to receive the bottom pillars. (Collection of Joseph H. Putro)

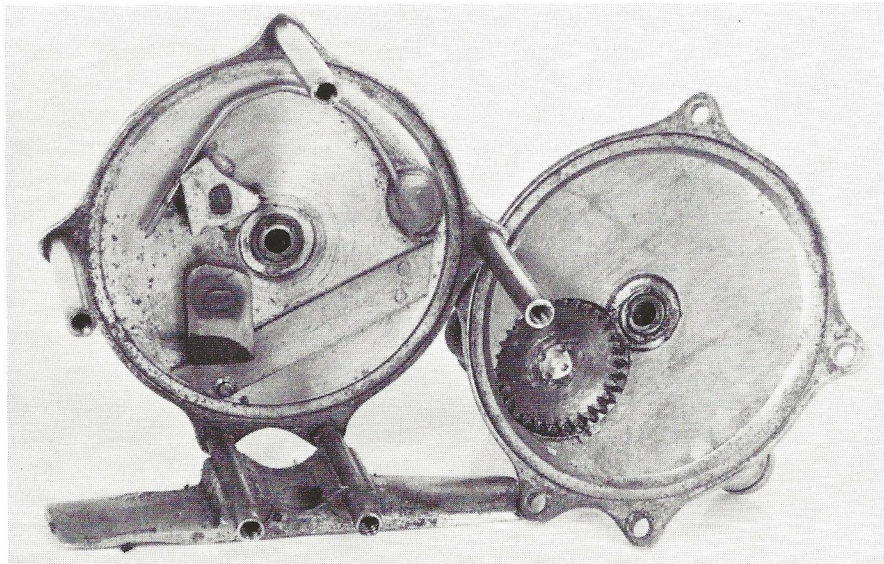

Inside of the unmarked reel with the spool removed. Note how the pillars rest in the grooved foot. The click, drag, and gear swaging are the same as those in the Whiting & Hendrick Bros. rubber-and-brass reel. (Collection of Joseph H. Putro)

so. Both Adna (probably a third son) and W. Irving were employed at the Henry B. Whiting firm, which advertised itself as "Manufacturer of Fishing Rods/Rod Fittings and Tackle of Every Description."² As his advertising did not mention bamboo, we believe Whiting built wood rods that were equipped with the ferrules, reel bands, and other fittings in which he specialized.

On March 27, 1884, disaster struck Ansonia when three local dams gave out and a flash flood coursed through the town. Whiting and a son escaped from their shop just before the building collapsed. The Derby Bit Company, where Bela was employed, also was destroyed. Fish-

ing rods were found in the debris for days afterward, and Whiting estimated that his losses amounted to \$4500-\$5000.

Hendrick reenters. Later in 1884, Whiting and Hendrick, along with Augustus' brother, George W. Hendrick, founded the firm of Whiting and Hendrick Bros., which was located at 97½ Court Street, New Haven. George had been employed by the E. N. Welch Company, which manufactured pendulum clocks in Forestville, and he had received a patent for a strike mechanism on June 15, 1880. According to its advertising, Whiting & Hendrick Bros. manufactured "Fishing Rods, Reels, and Rod Mountings."³ How these gentlemen agreed on such a venture is a matter for speculation. Whether Whiting first suggested the idea of reelmaking to clockmaker Hendrick or Hendrick saw an opportunity to try his hand at reelmaking with the flooded-out Whiting will never be known. The order of the names in the company title suggests that Whiting provided the lion's share of the capital investment, but it

BUY THE MASCOT FISHING REELS.

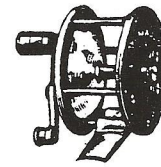

The Best Multipliers made.
If your dealers cannot supply you, send direct to factory, and we will tell you where you can get them.

The Star Reel Works, Birmingham, Conn.

The earliest known advertisement for Star Reel Works, published in the December, 1890, issue of Harper's New Monthly Magazine. Except for the model name and the sliding buttons, the reel shown appears to be identical to the rubber-and-brass Whiting & Hendrick reel, including the machined foot. It is not certain how long the "Mascot" brand name was used.

is possible that the title was designed to provide instant recognition of Whiting's name as a long-established maker of fishing equipment. The new firm produced both raised-pillar and conventional multipliers, at least some of which were marked.

Hendrick's earliest reels presumably would have been made during his tenure at the Whiting & Hendrick Bros. firm, and we have examined two reels marked with the company name. Both also are marked "PAT APL'D FOR," but we doubt that any such patent was granted. The first reel is a narrow-frame, hard-rubber and plated-brass

(No Model.)

G. F. LOOMIS.
FISH LINE REEL.

No. 459,511.

Patented Sept. 15, 1891.

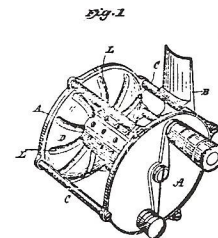

The drawings for Loomis' 1891 patent, showing the ventilated spool and corrugated spool flanges. The crank (though reversed) and the grooved foot are earmarks of Hendrick construction.

REELS,
Rod Trimmings.
Patented Solderless Tie Guides.
ISAAC J. BOOTHE,
BIRMINGHAM. - CONN.

Isaac Boothe's advertisement in American Angler, ca. 1888. (Courtesy of American Museum of Fly Fishing)

(Model.)

A. D. HENDRICK.
FISHING REEL.

No. 485,794.

Patented Nov. 8, 1892.

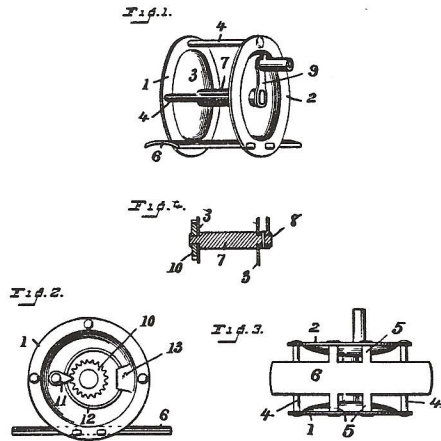

The drawings for Hendrick's 1892 patent.
Note the design for the foot in Fig. 3.

multiplier with arrow-shaped levers on the tailplate that operate a brake and click. Screws hold the pillars at both ends, and the crank, a reverse-S, bears a hard-rubber, slightly tapered, almost cylindrical knob with three shallow, circumferential grooves. The foot is a one-piece casting machined to look like two pillars extending from holes drilled through thickenings in the foot proper. The gear train consists of a fifteen-tooth pinion swaged on the round spool shaft and a thirty-tooth brass main gear swaged to a steel crankshaft. No internal bearing is provided for the crankshaft. The click mechanism comprises a pawl swivelled by one of the arrow-shaped levers and retained by a curved wire spring soldered to the brake spring.

The second Whiting & Hendrick Brothers reel is a nickel-plated brass, raised-pillar multiplier. The pillars are riveted to the tailplate and screwed to the headplate, but the foot is held by four screws. The foot, levers, and crank are similar to those of the first reel.

The Whiting-Hendrick association was not to last long. After 1885, the

firm's name did not appear in New Haven directories, though Whiting was listed as a rodmaker in 1885-86 and 1886-87 Derby directories. The *New Haven Directory* for 1886 carried the advertisement of "Hendrick Bros., Manufacturers of Fishing Rods, Reels, and Rod Mountings." The newly named company was located at 122 Court St., New Haven. Clearly, Whiting had left the firm. Nevertheless, his patent for a solderless, tubular rod guide, granted on March 16, 1886, was assigned to the two Hendrick brothers, who probably bought out Whiting's share of the business, including the patent rights. The concave base of

the guide would have made it more suitable for turned wood rods than for flat surfaces of split bamboo. Perhaps Whiting continued to make rods for the company under contract; perhaps George Hendrick attempted to make the equipment for which Whiting had been responsible. By 1887, Whiting moved to Brooklyn, N.Y., following Adna, who had moved there a year earlier.

The breakup continued. An advertisement in the 1887 *New Haven*,

Directory mentioned only "A. D. Hendrick, Manufacturer of Fishing Reels and Guides," at 83 Court St. Obviously, Augustus had abandoned clockmaking and was now "going it alone" in the fishing tackle business. His product line became more specialized. Although we know what some of his reels looked like, we are not certain of his whereabouts during the following few years.

Two unmarked, plated-brass reels resembling the Whiting & Hendrick Brothers raised-pillar reel have been examined. One is virtually identical to the marked reel. The other shows one significant difference: Instead of being a machined casting, the foot has deep grooves in its thickenings in which the bottom pillars are soldered. The gears have fifteen and thirty teeth, and the main gear is swaged to the crankshaft with a punch pattern identical to that in the other marked reel. The click spring is soldered to the brass tailplate.

We believe that the unmarked reels represent somewhat later products than the marked ones. Once Whiting left the firm, Hendrick probably did not bother having a new die made for the twice-renamed company. The grooved foot certainly would have been easier to make and would have

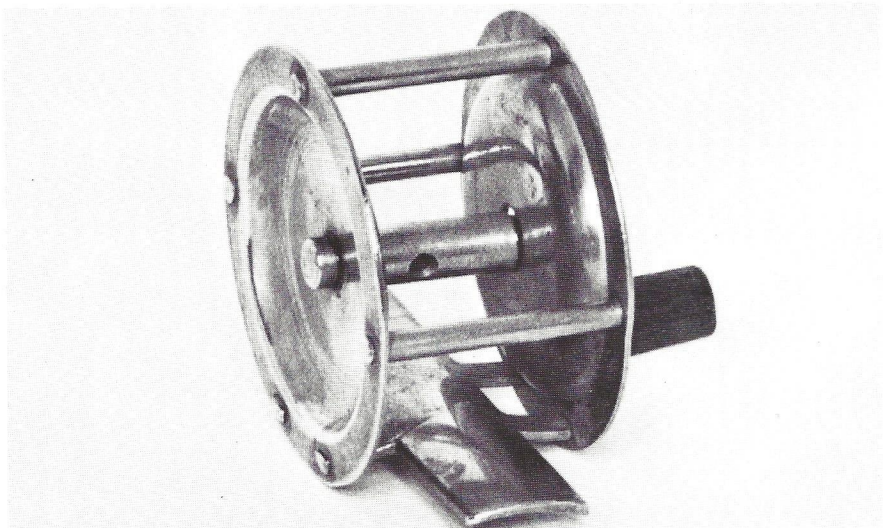

A Star Reel Works version of Hendrick's patented reel. The riveted, concave brass sideplates allegedly eliminate the need for a spool. Note the one-piece foot.

been less wasteful than the machined, probably earlier, foot.

One other reel deserves mention as a possible early Hendrick product. A nickel-plated, conventional multiplier has been tentatively identified as a Whiting & Hendrick Bros. reel through its machined foot and arrow-shaped, headcap-mounted lever.⁴ However, the shapes of both the lever and the crank allow for the possibility that the reel was made elsewhere.

Having lost sight of Hendrick in 1887, we pick up the trail of one Isaac Judson Boothe, of Birmingham, who advertised his "Reels, Rod Trimmings. Patented Solderless Tie Guides." in an issue of *American Angler*, ca. 1888. Boothe was born in Stratford, Connecticut, on July 5, 1861, into a wealthy and locally influential family. During his youth, he dropped out of Yale University and toured Europe in hopes of strengthening his poor health. Returning to this country, he was living at 94 Elizabeth, Birmingham, by 1882. Within six years, at least before his twenty-seventh birthday, he became the president of the Birmingham Wire Nail Company. The late 1880's were busy years for Boothe, for the 1890-91 *Derby Directory* listed him both as as-

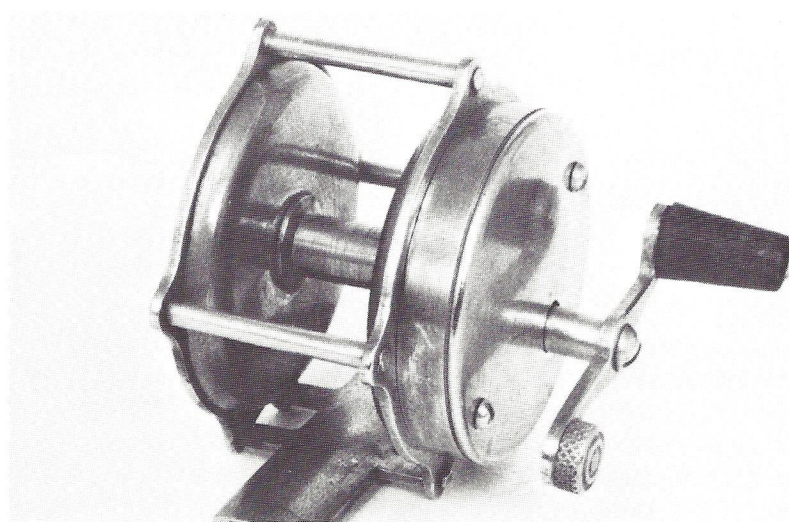

Another brass reel with the Hendrick foot. Both this and the Loomis-spool reel are surprisingly heavy and spin smoothly. Each has a sliding click on the tailplate. Neither reel has a crank collar; both have "reverse-S" cranks with knurled counterweights and truncated conical wood knobs. Presumably, both reels were made by Star Reel Works.

sociated with the National Keg and Box Company and as proprietor of the Star Reel Works. The listing is the earliest printed reference to the reel company that we have discovered. Both companies were located at 132 Main St., Birmingham. We infer that Boothe founded the fishing equipment firm about 1888 and chose the name a year or so later. The company placed an advertisement in the December, 1890, issue of *Harper's New Monthly Magazine*

touting "Mascot" fishing reels, "The Best Multipliers made." The "Mascot" shown is the "spittin' image" of the rubber-and-brass Whiting & Hendrick Bros. reel, except that it includes sliding buttons on the tailplate for the click and drag.

To our delight, Augustus D. Hendrick was described as an employee of Star Reel Works in the *Ansonia, Birmingham, Derby, and Shelton Directory* for 1892. It is reasonable to suppose that Hendrick had left New Haven to work for Boothe, perhaps as early as 1888. Boothe's advertisement for patented guides suggests that the guides were based on Whiting's patent and that he acquired the patent rights along with Hendrick's business. Living with Hendrick at 196 Cliff Avenue, Shelton, were his sons Herbert and Herman, who also were employed by the reelmaking firm.

We believe that the cause of the rapid demise of the Whiting-Hendrick association probably was its reliance on sales from a retail store in New Haven. Perhaps Whiting and George Hendrick realized that the business simply would not support all three partners and their families. Subsequently, Augustus

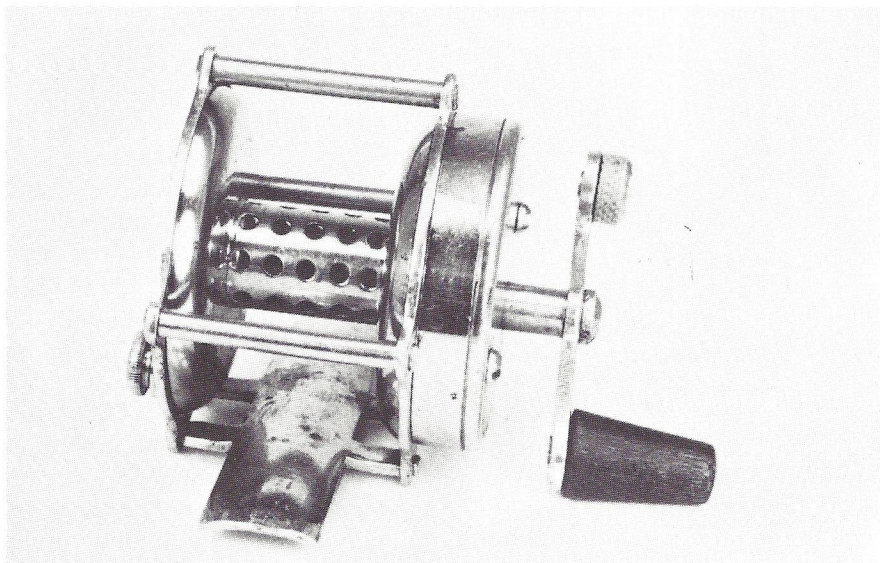

This Star Reel Works multiplier combines the ventilated spool arbor of the Loomis patent with the reel foot of the Hendrick patent. The reel is made of plated brass.

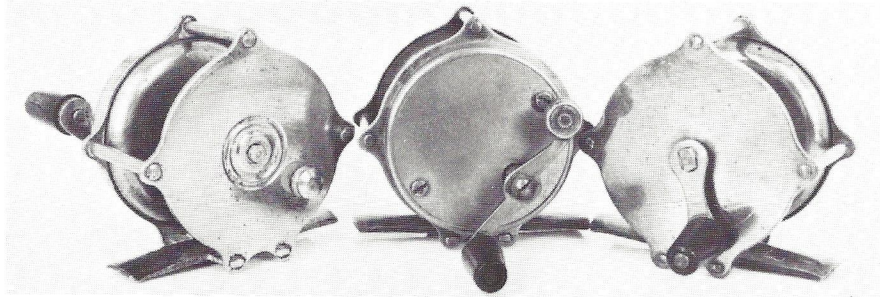

Three brass reels made by Star Reel Works and employing the Hendrick one-piece foot. The multipliers (left and center) are virtually identical, but the single-action reel has a half-crank with the typical Star knob.

Hendrick may have approached Boothe to seek financing for continued tackle manufacturing. Boothe's introduction of national advertising indicates that he envisioned a much more widely based, wholesale market than did Hendrick. Hendrick and his sons were willing to stake their futures on the success of the new company.

A brief digression is necessary at this point. On December 22, 1890, Charles F. Loomis, an employee of the Whitlock machine shop at 96 Main St., Birmingham, filed an application for a patent of a fishing reel. His single-action reel employed a hollow, perforated crankshaft. Between the spool flanges, a perforated sleeve enclosed the shaft and acted as the spool arbor. The design was meant to ameliorate ventilation of the line and permit it to dry. In addition, the spool flanges were formed with radial corrugations, which were supposed to permit air to circulate along the sides of the line coil. Loomis also explained that with the perforations and corrugations, "the transmission of the sound of the click along the taut line to the water...is very much lessened, if not entirely prevented, by the presence of a body of air in the axis of the coils of line and by reason of the small bearing-surface of the coil of line on the spool-heads" (flanges). The patent was granted on September 15, 1891. The Star Reel Works acquired rights to the design, for at least one style of their reels incorporated the perforated arbor

and hollow shaft, though not the corrugated flanges. We have not yet detected the sound of the click underwater.

Loomis makes only a cameo appearance in our story. Born in Massachusetts, he moved to Derby around 1866 and apparently continued his employment as a machinist until December 8, 1896, when he died of a stroke as he was climbing the stairs to a doctor's office.

A few months after the Loomis patent was granted, De Witt C. Lockwood, of Shelton, filed a patent application for a means of attaching a reel to a rod. Born in 1825, Lockwood was a wood turner specializing in fine chess pieces, as well as an ardent sportsman. He was the owner of the Corset Steel Tipping company by 1896; the company's address was

96 Main Street, the same location where Loomis worked. The invention comprised a plug on the butt-end of the rod, to which was attached a corresponding socket mounted on the reel base. The fittings could be threaded or "bayonet-mounted," but whichever method was used would provide a means of attaching the reel at the butt in a balanced fashion. Furthermore, if a second plug was fitted above the rod handle, the reel could be mounted either for fly-fishing or bait-casting. The reel was shown with an elongated-diamond crank. Lockwood's patent was granted on Oct. 18, 1892, but we have no evidence that the invention was employed commercially. The inventor died on December 20, 1903.

On March 2, 1892, Augustus Hendrick filed a patent application for what must be a contender for the cheapest fishing reel ever made. The patent, granted on November 8 and assigned to Isaac J. Booth [sic], described a single-action reel with concave sideplates which bore, at their centers, the only moving part of the reel--the crankshaft, which functioned as an arbor. As the sideplate design simulated spool flanges, the inventor felt that no spool was necessary for properly winding the line. A click mechanism mounted on

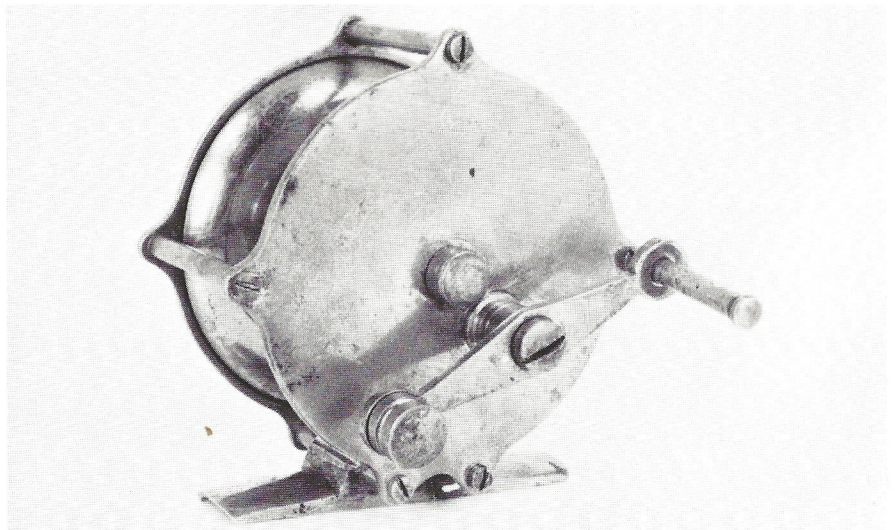

An example of a later Hendrick reel, possibly a "Mascot." Although the knob is missing, the reel has a resoldered, grooved foot. The crank is an elongated diamond, rather than a reverse-S.

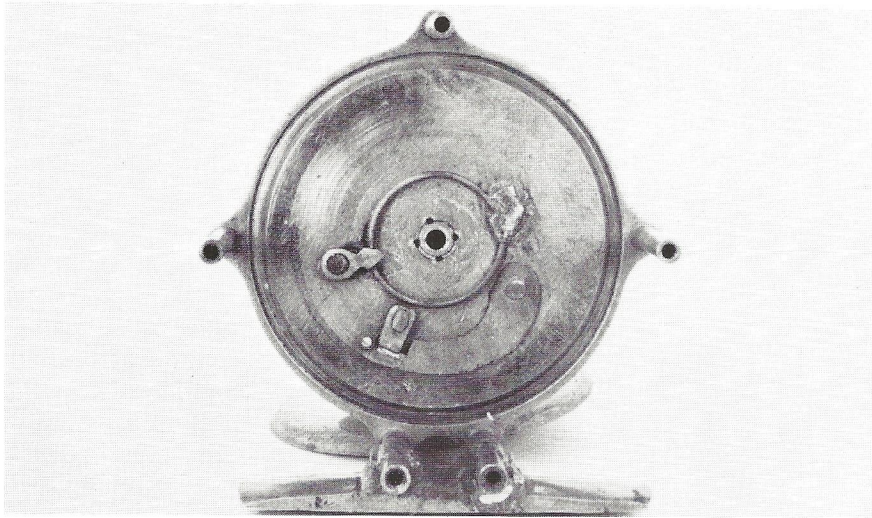

The drag spring of the later Hendrick reel is pressed outward by a sliding block.

Both click and drag are operated by sliding buttons. The spool bearings are swaged into the sideplates, and the brass main gear is swaged similarly to a steel crankshaft.

the outside of the tailplate was allegedly protected within the plate concavity. Another feature provided the key by which at least some of the Star Reel Works products can be identified. Hendrick's third claim included a sheet-metal reel foot with four integral projections that were riveted to the sideplates. We can only guess to what degree the boss was impressed by this feat of engineering.

The applications for the Lockwood and Hendrick patents were filed only four days apart by the same attorney. We infer that Lockwood and Loomis worked at the same address and that at least Loomis, in the Whitlock shop, probably was manufacturing parts for Hendrick and Star Reel Works. Perhaps inspired by Hendrick's creative energy, they temporarily turned their attention to improving fishing equipment.

By the end of 1892, then, Isaac Boothe was running The Star Reel Works, which employed the three Hendricks and controlled the rights to at least two reel patents. During the next five or six years, Star does not appear to have undergone any significant changes, except for a change of address to 90 Main St. The Hendricks continued to live together

at least until 1900, although their street address changed twice in the interim. Augustus and Herbert remained employees at Star until 1898, while Herman became a ball player by 1896, an employee of R.T.E. Company by 1899, and a shipping clerk at the B. Corset Company by 1900.

The Star Reel Works faded from view in 1897 or 1898. The *Ansonia and Derby Directory* for 1898 no longer listed Boothe as the proprietor of the company, labelling him an unaffiliated, fishing rod and

reel manufacturer. In 1899 and 1900, Augustus and Herbert were listed in the *Derby and Shelton Directory* as reelmakers, but, again, no mention was made of the company name. According to Hendrick's obituary, the business "was sold to out-of-town parties and moved to Waterville," a northern section of Waterbury. By 1901, the three Hendricks, as well, were employed in Waterbury. Although it is possible that the Hendricks tried to establish their own reelmaking business during 1899-1900, it seems more likely that they remained with the company until the new owners relocated it. We do not know whether or not the Waterville firm retained the company name.

On April 20, 1901, Augustus D. Hendrick fell dead on a Shelton street, apparently of a heart attack, as he was returning home alone from the Waterbury factory in which he worked. His son Herbert, who worked at the same factory, normally accompanied his father home, but on that day he had left, ironically, to attend a funeral. We can only assume that the Hendricks were still making reels for the purchasers of the Star Reel Works.

Isaac Boothe continued his entrepreneurial habits and was President of the Eastern Lumber &

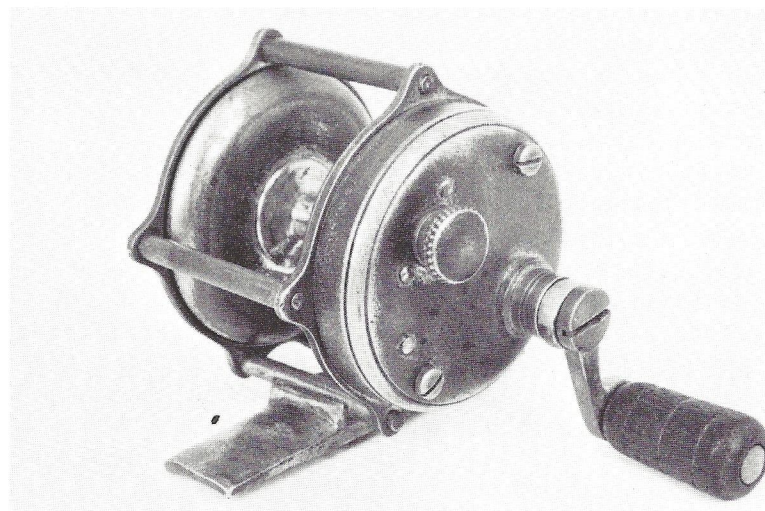

This tiny multiplier is probably a late, Hendrick-style reel. The counterbalance end of the crank has been filed off. The knob rotates a triangular click pawl.

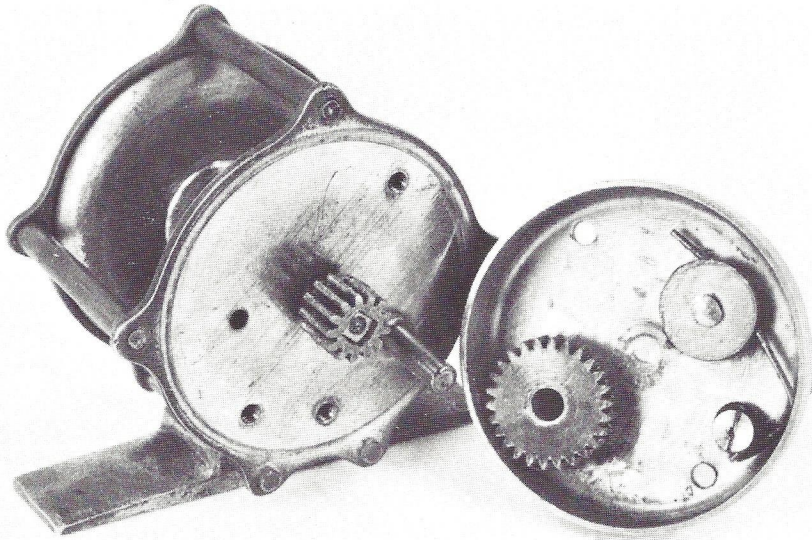

The click, removable pinion, and main gear shaft-bearing are not typical features of the Hendrick-style reels we have seen.

Box Company by 1900. He spent the next two years merging various Canadian and New England shoo and lumber firms into the Colonial Box and Lumber Company, a New York-based concern capitalized for \$15,000,000. He had little chance to celebrate his success, however. On July 14, 1902, he died from the effects of a gangrenous, ruptured appendix only days after his forty-first birthday.

Augustus Hendrick and his family were building reels for at least seventeen years in southern Connecticut, but few of his products have been identified. Only the Whiting & Hendrick Bros. reels seem to have been marked with a company name. The change in foot construction on reels otherwise identical to the marked ones indicates that Star Reel Works continued to manufacture reels of that style after the Hendricks left New Haven. The "Mascot" illustration of 1890 shows a machined foot, while the 1891 Loomis patent shows a grooved foot. Therefore, Hendrick may have developed the grooved style as late as 1890. The "Mascot" illustration also shows sliding buttons for the click and drag, which probably replaced the relatively complex lever-operated mechanisms.

The reels thus far attributable to Star Reel Works and/or its Waterbury successor appear to fall into two broad categories: Those that employ the grooved foot and those that include the sheet-metal foot of the Hendrick patent. The reels employing the patented foot obviously represent a cheaper product line. Based on features of the Hendrick or Loomis patents, six such reels illustrated here are attributable to Star Reel Works. Of the six, five are 2:1 raised-pillar multipliers, and the sixth is a single-action reel of similar style.

Several reels with the grooved foot demonstrate a variety of styles. Two unusual multipliers (see cover photo) are made with hard-rubber sideplates, fitted with metal disc inserts, and both German silver and brass parts. The metals are plated with nickel. The pillars and most of the other metal parts are decorated with knurling or engraving, and the larger version includes domed, "rosette" washers. The reels have sliding-button clicks, but no drags, and cranks shaped like elongated diamonds, rather than reverse-S's. Superficially resembling a Julius vom Hofe design, each reel has a recess cut through the headplate to house the gears, much like the recess

shown in vom Hofe's patent no. 330,811. That patent, applied for on August 28, 1885, describes a reel with rubber sideplates strengthened by external metal discs, in which the spool bearings are bushed. However, vom Hofe claimed the addition of a bridge that spanned the sideplate recess and supported the main gear. The engraved reels have no such bridges, and the brass main gears are swaged to steel crankshafts as in the Hendrick raised-pillar reels. In addition, the rubber crank knob on the larger reel (the smaller has a bone or ivory knob), the swaging of the pinions on round spool shafts, the thirty- and fifteen-tooth gear trains, and the grooved foot design all are earmarks of the Hendrick raised-pillar reels. The similarity to the vom Hofe reels is probably not coincidental.

Although it resembles the Whiting & Hendrick reels, another raised-pillar reel with the grooved foot employs a diamond-shaped crank and sliding buttons for the click and drag. The internal construction is the same as that of the earlier reels. We believe that this reel is essentially the same as the "Mascot" reels advertised after the turn of the century (see below).

The last grooved-foot reel we have examined is the most enigmatic. It is a raised-pillar multiplier with a reverse-S crank (The counterbalance end has been filed off.), a Star cylindrical knob, and a headcap that is actually a flat dome. The click is operated by a rotating button that pivots a triangular pawl to contact the pinion. The pinion is seated on a squared spool shaft and is removable. The brass main gear is attached to a brass, not steel, crankshaft, and is seated on a shaft-bearing. As several of these features are clearly different from the other Hendrick reels, we believe this last reel may be the latest Hendrick-style reel we have seen; it may be a product of the Waterbury company.

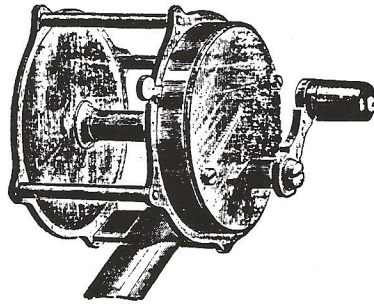

No. C2.

Star Multiplying, with Drag.

Nos.,	C2	C3	C4
Yards,	40	60	80
Per Dozen, \$8.00		9.00	10.50

The "Star" reel featured in the 1895 catalog of Markley, Alling & Co. The other three reels shown on the same page were Hendryx products.

There are a few hints as to what some of the other Hendrick reels may have looked like. The 1895 catalog for the Chicago hardware firm of Markley, Alling & Co. contained an illustration of a simple raised-pillar multiplier with a stamped foot, riveted frame, collarless crank, and rim-lever drag. The reel is named "Star Multiplying." We can think of no better reason for such a label than the reel's manufacture by Star Reel Works. An illustration for a remarkably similar reel in the 1888 Thos. H. Chubb catalog includes the engraver's mark: A. MUGFORD. HFD. CT. The only other engraver marks among the reel illustrations are those of a New York engraver. Therefore, it is reasonable to suppose that the engravings with the "CT." marks were made in Connecticut and probably show reels made in that state. Similar reels were virtually ubiquitous in catalogs of that era. Is it possible that Star Reel Works made most or all of them?

A catalog issued in 1895 by Montgomery Ward & Co. contains an illustration of a plated single-action reel that almost certainly was made by Star Reel Works. In addition to having a conical crank knob, the reel appears to employ the Hendrick-patented foot. Elsewhere on the same page are two other pos-

sible Star reels, one of which is described as "raised pillar, star pattern." This reel is a sheet-metal, single-action reel similar to many others found in contemporary catalogs. It is astonishing that the previously unheard-of company was capable of supplying reels to such a retailing giant.

The Sears, Roebuck Company catalog for Fall, 1900, advertised "Our Mascot Reel," which was offered in 60 yd., 80 yd. and 100 yd. sizes. Their 1902 catalog pictured "Our Mascot Multiplying Reel, 65 Cents...Every reel is stamped Mascot." Though crude, the illustration demonstrates Hendrick-style features. The screwed-frame construction and grooved foot style suggest that it is a higher quality reel than the one in the Montgomery Ward catalog. The 1900 catalog also illustrates a solderless line guide that appears to represent Whiting's fourteen-year-old patented design. It seems likely that Boothe's "Mascot" brand was continued (or revived) by the owners of the Waterbury reel factory and that they continued supplying a national wholesale market. Reel food for thought.

If additional research confirms what this circumstantial evidence suggests, Augustus D. Hendrick was responsible for an enormous number of relatively inexpensive trade reels sold in this country during the late nineteenth century. Once we realized how to identify some of his reels, we discovered nine reels in our own collections attributable to his manufacture. The only other two collections we examined contained several more such reels. Two of the reels illustrated were found at two different flea markets over the same weekend as we worked on a final draft of this article. These numbers hint at a widespread distribution of these previously unidentified reels. Augustus Hendrick may well deserve to be ranked among America's most successful, perhaps even influential, reelmakers.

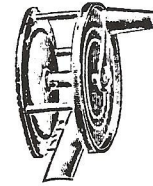

18515 Single Action, nickel, plain click, safety band, light and strong, a good fly reel; plain free runner, will fit any reel band, 40 yards.....\$0.30 Extra, by mail......03

Our Mascot Reel.

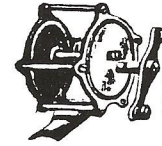

No. 38767 This is one of the very best double multiplying reels on the market. It is full nickel plated, with balance handle, double screw-off oil cap, which is preferable to reels with the old style cumbersome oil caps. It is one of the easiest and smoothest running reels on the market, the bearings being of steel. They have back sliding click and drag. Every reel stamped Mascot cannot become otherwise than popular.
 No. A 60 yard reel. Our special price..... \$1.00
 No. B 80 yard reel. Our special price..... 1.50
 No. C 100 yard reel. Our special price..... 2.25

Solderless Tie Guides.



No. 39113 Solderless Tie Guides; brass, any size from No. 1 to No. 5. No. 5 is smallest. Per dozen.....25c

(Top) An illustration from an 1895 Montgomery Ward & Co. catalog showing a reel made by Star Reel Works. The extensions of the Hendrick-patented foot are visible. (Middle) The "Mascot" reel shown in the Sears, Roebuck Co. catalog for Fall, 1900, and in later catalogs, as well. Note the crank knob. (Bottom) The solderless guides shown in the 1900 catalog appear to be made in accord with Whiting's patent design.

Footnotes:

- ¹The Evening Sentinel, April 22, 1901.
- ²Derby Directory, 1883-84, p. 204.
- ³New Haven Directory, 1884, p. 557.
- ⁴Karl T. White, personal communication.

Acknowledgements:

We are deeply grateful to the following for their help in preparing this article:
 Nicholas and Carol Buonato, The Moon Dial
 Alanna D. Fisher, American Museum of Fly Fishing
 Karen Hallbach, Derby Public Library
 Dorothy Larson, Derby Historical Society
 Joseph H. Putro
 Karl T. White, National Fishing Tackle Museum